

# Deutsches Institut für Bautechnik

Anstalt des öffentlichen Rechts

Kolonnenstr. 30 B  
10829 Berlin  
Germany

Tel.: +49(0)30 787 30 0  
Fax: +49(0)30 787 30 320  
E-mail: [dibt@dibt.de](mailto:dibt@dibt.de)  
Internet: [www.dibt.de](http://www.dibt.de)

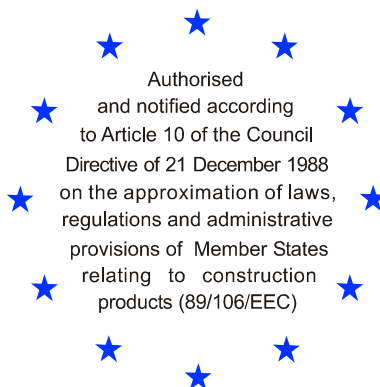

# DIBt

Mitglied der EOTA  
*Member of EOTA*

## European Technical Approval ETA-05/0262

English translation prepared by DIBt - Original version in German language

Handelsbezeichnung <i>Trade name</i>	THERMOSPAN - Schalungs-/Mantelsteine (Schalungssteine) aus Holzspanbeton <i>THERMOSPAN - shuttering blocks made of wood-chips aggregate concrete</i>
Zulassungsinhaber <i>Holder of approval</i>	Thermo-span Baustoffwerk St. Johann Harml & Quehenberger GmbH Maschl 28 5600 ST. JOHANN/PG ÖSTERREICH
Zulassungsgegenstand und Verwendungszweck  <i>Generic type and use of construction product</i>	Nicht lasttragendes verlorenes Schalungssystem "THERMOSPAN" bestehend aus Schalungs-/Mantelsteinen (Schalungssteinen) aus Holzspanbeton  <i>Non-load bearing permanent shuttering kit "THERMOSPAN" based on shuttering blocks of wood-chips aggregate concrete</i>
Geltungsdauer: <i>Validity:</i>	6 December 2005
	6 December 2010
verlängert vom <i>extended from</i>	14 December 2010
bis <i>to</i>	14 December 2015
Herstellwerk <i>Manufacturing plant</i>	T1 T2

Diese Zulassung umfasst  
*This Approval contains*

24 Seiten einschließlich 10 Anhänge  
*24 pages including 10 annexes*



Europäische Organisation für Technische Zulassungen  
European Organisation for Technical Approvals

## I LEGAL BASES AND GENERAL CONDITIONS

- 1 This European technical approval is issued by Deutsches Institut für Bautechnik in accordance with:
  - Council Directive 89/106/EEC of 21 December 1988 on the approximation of laws, regulations and administrative provisions of Member States relating to construction products<sup>1</sup>, modified by Council Directive 93/68/EEC<sup>2</sup> and Regulation (EC) N° 1882/2003 of the European Parliament and of the Council<sup>3</sup>;
  - Gesetz über das In-Verkehr-Bringen von und den freien Warenverkehr mit Bauprodukten zur Umsetzung der Richtlinie 89/106/EWG des Rates vom 21. Dezember 1988 zur Angleichung der Rechts- und Verwaltungsvorschriften der Mitgliedstaaten über Bauprodukte und anderer Rechtsakte der Europäischen Gemeinschaften (Bauproduktengesetz - BauPG) vom 28. April 1998<sup>4</sup>, as amended by law of 31 October 2006<sup>5</sup>;
  - Common Procedural Rules for Requesting, Preparing and the Granting of European technical approvals set out in the Annex to Commission Decision 94/23/EC<sup>6</sup>;
  - Guideline for European technical approval of "Nonload-bearing permanent shuttering systems based on hollow blocks or panels of insulating materials and sometimes concrete", ETAG 009.
- 2 Deutsches Institut für Bautechnik is authorized to check whether the provisions of this European technical approval are met. Checking may take place in the manufacturing plant. Nevertheless, the responsibility for the conformity of the products to the European technical approval and for their fitness for the intended use remains with the holder of the European technical approval.
- 3 This European technical approval is not to be transferred to manufacturers or agents of manufacturers other than those indicated on page 1, or manufacturing plants other than those indicated on page 1 of this European technical approval.
- 4 This European technical approval may be withdrawn by Deutsches Institut für Bautechnik, in particular pursuant to information by the Commission according to Article 5(1) of Council Directive 89/106/EEC.
- 5 Reproduction of this European technical approval including transmission by electronic means shall be in full. However, partial reproduction can be made with the written consent of Deutsches Institut für Bautechnik. In this case partial reproduction has to be designated as such. Texts and drawings of advertising brochures shall not contradict or misuse the European technical approval.
- 6 The European technical approval is issued by the approval body in its official language. This version corresponds fully to the version circulated in EOTA. Translations into other languages have to be designated as such.

---

1 Official Journal of the European Communities N° L 40, 11 February 1989, p. 12

2 Official Journal of the European Communities N° L 220, 30 August 1993, p. 1

3 Official Journal of the European Union N° L 284, 31 October 2003, p. 25

4 *Bundesgesetzblatt Teil I* 1998, p. 812

5 *Bundesgesetzblatt Teil I* 2006, p.2407, 2416

6 Official Journal of the European Communities N° L 17, 20 January 1994, p. 34

## **II SPECIFIC CONDITIONS OF THE EUROPEAN TECHNICAL APPROVAL**

### **1 Definition of product and intended use**

The shuttering system "THERMOSPAN" is a non-load-bearing permanent shuttering kit based on shuttering blocks (see e.g. Annex 1) applicable as formwork for plain and reinforced concrete walls cast in-situ.

#### **1.1 Definition of the construction product**

The shuttering blocks consist of wood-chips aggregate concrete. The normal blocks are shuttering blocks with one or more closed full-length hollow spaces in the middle and at each end there is an open hollow space of half of the length  $d_1$  (see e.g. Annex 1, Fig. 1 to 7). For the horizontal surfaces a form fit is not foreseen but the static friction between the surfaces is high enough to avoid sliding when stacking the shuttering blocks together and placing the concrete in the wall.

The length of the normal blocks ranges from 500 mm to 1250 mm and the height is 250 mm.

Shuttering blocks with a thicker outside shuttering leaf or inserts of thermal insulation are generally used for external load-bearing walls. The thickness of the outside shuttering leaves of the shuttering blocks ranges from 25 mm to 105 mm. The inner leaves are 25 mm to 45 mm thick. Shuttering blocks with equal thickness for the inside and outside shuttering leaves are also used for internal walls.

The maximum thickness of the space for the concrete core is 235 mm, the minimum thickness 90 mm.

Special shuttering blocks such as stopper blocks are also part of the system.

Lintel shutterings are made of special blocks by cutting all the webs inside of the shuttering block. The maximum height of the shuttering leaf of such a lintel shuttering shall not exceed 75 cm.

From the above mentioned normal shuttering blocks it is also possible to prefabricate storey high shuttering elements by sticking together the shuttering blocks in bond with adhesive to wall elements. Such elements are at maximum 6 m long and 3.50 m high.

#### **1.2 Intended use**

The kit is intended to be used for construction of internal walls as well as external walls above or below ground which are load-bearing (structural) or non load-bearing (non structural), including those which are subject to fire regulations.

When using this type of construction below ground a waterproofing according to applicable national rules shall be provided depending on whether ground water not exerting pressure or ground water exerting pressure is to be dealt with. The waterproofing shall be protected from mechanical damage by a smash-resistant protective layer.

Furthermore also applications for alone standing walls, like fences for gardens or noise protection walls are possible.

The provisions made in this European technical approval are based on an assumed working life of the shuttering kit of 50 years, provided that that the conditions laid down in sections 4.2, 5.1 and 5.2 for the packaging, transport, storage, installation, use, maintenance and repair are met. The indications given on the working life cannot be interpreted as a guarantee given by the producer, but are to be regarded only as a means for choosing the right products in relation to the expected economically reasonable working life of the works.

## 2 Characteristics of product and methods of verification

### 2.1 Shuttering blocks

The shuttering blocks correspond to the information and drawings given in Annex 1 and 2. The characteristic data of the normal and stopper blocks of the kit are given in the tables of Annex 1 and 2.

Lintel shutterings are made of special blocks (Fig. 1 to 7 of Annex 2) by cutting all the webs inside of the shuttering block. The maximum height of the shuttering leaf of such a lintel shuttering shall not exceed 75 cm.

From the normal shuttering blocks it is also possible to prefabricate storey high shuttering elements by sticking together the shuttering blocks in bond with adhesive to wall elements (see Annexes 5 to 7). Such elements at maximum are 6 m long and 3.50 m high.

The wood-chips aggregate concrete of the shuttering blocks is classified in the density classes  $\rho_{tr}$  500 kg/m<sup>3</sup> and 600 kg/m<sup>3</sup>. The correlation of the different types of shuttering blocks to the different density classes can be taken from Annex 4.

The materials for the inserts of thermal insulation (see Fig. 3 to 7 in Annex 1 and 2) are mineral wool, expanded polystyrene, extruded polystyrene foam, polyurethane foam and expanded cork. The minimum requirements for different insulating materials have to meet at least the values of the following table 2:

Table 2: Requirements of the different insulating materials

Insulating material	Standard	Requirements for inserts of thermal insulation (see Fig. 3 to 7 in Annex 1 and 2)
mineral wool (MW)	EN 13162	MW-EN 13162-T4-DS(T+)-CS(10\Y)60-TR7,5
expanded polystyrene (EPS)	EN 13163	EPS-EN 13163-T1-L1-W1-S1-P3-DS(70, -)3-BS50-DS(N)5
extruded polystyrene foam (XPS)	EN 13164	XPS-EN 13164-T1-DLT(2)5-CS(10\Y)300-DS(TH)-CC(2/1,5/50)130-WD(V)3-FT1
polyurethane foam (PUR)	EN 13165	PUR-EN 13165-T2-DS(TH)9-CS(10\Y)120-TR40
expanded cork (ICB)	EN 13170	ICB-EN 13170-T2-L2-W2-CS(10)100-TR40-WS

The insulating material is delivered CE marked according to the product standards in form of plates and has to be cut to the size of the inserts.

The material characteristics, dimensions and tolerances of the shuttering blocks not indicated in the Annexes are given in the technical documentation<sup>7</sup> of the ETA.

<sup>7</sup> The technical documentation of the ETA is deposited at DIBt and, as far as relevant for the tasks of the approved bodies involved in the attestation of conformity procedure, is handed over to the approved bodies.

## 2.2 Methods of verification

### 2.2.1 General

The assessment of the fitness of the shuttering system for the intended use has been made in compliance with ETAG 009, Guideline for European technical approval of "Non load-bearing permanent shuttering kits/systems based on shuttering blocks or blocks of insulating materials and sometimes concrete", edition June 2002.

The ETA is issued for the shuttering system "THERMOSPAN" on the basis of agreed information, deposited at Deutsches Institut für Bautechnik (DIBt), which identifies the shuttering kit that has been assessed and evaluated. Changes to the production process, the kit or the components which could result in this deposited information being incorrect, shall be notified to DIBt before the changes are introduced. DIBt will decide whether or not such changes affect the ETA and consequently the validity of the CE marking on the basis of the ETA, and, if so, whether further assessment and/or alterations to the ETA shall be necessary.

### 2.2.2 Essential Requirement 1: Mechanical resistance and stability

#### 2.2.2.1 Resulting structural pattern

In end use conditions walls made with the shuttering system "THERMOSPAN" are walls of grid type according to ETAG 009, paragraph 2.2.

#### 2.2.2.2 Efficiency of filling

Considering the instructions of chapter 4.2 and the installation guide of the ETA holder, the efficient filling of the shuttering without bursting voids or any uncovered reinforcement in the concrete core is possible.

The requirements according to ETAG 009, chapter 6.1.2 are met satisfactorily.

#### 2.2.2.3 Option of steel reinforcement

Only steel reinforcement according to chapter 4.2.3 and according to the installation guide by the ETA holder may be installed.

Under the above-mentioned limitations the requirements according to ETAG 009, chapter 6.1.3 are met satisfactorily.

### 2.2.3 Essential Requirement 2: Safety in case of fire

#### 2.2.3.1 Reaction to fire

The surface of the walls with the types of shuttering blocks indicated with \* in Annex 1, meets the requirements for Class A2-s1 d0<sup>8</sup> according to EN 13501-1.

For all types of shuttering blocks not indicated with \* in Annex 1, the "No performance determined" option (Class F according to EN 13501-1) is used.

#### 2.2.3.2 Resistance to fire

In dependence of the thickness of the concrete core, the walls meet the criteria according to ETAG 009, Annex C, table 1, third column (see following table).

---

<sup>8</sup> A European reference fire scenario for facades has not been laid down. In some Member States the classification of permanent shuttering systems according to EN 13501-1 might not be sufficient for the use in facades. An additional assessment of permanent shuttering systems according to national provisions (e.g. on the basis of a large scale test) might be necessary to comply with Member States regulations, until the existing European classification system has been completed.

The preconditions for the use of the following table are:

- The design of the building has to take the secondary effects of fire into account. Especially constraints, introduced by thermal strain, should be sufficiently low and appropriate building joints should be provided for. The rules, effective at the place of use, shall apply. Structural requirements under normal conditions, applicable at the place of use, may require larger dimensions. Concrete cover for the reinforcement has to be observed according to the rules, applicable at the place of use.
- A normal weight concrete as defined in EN 206-1 shall be used. If EN 206-1 is not in force, an equivalent concrete according to national rules, applicable at the place of use, is acceptable.
- The strength of concrete shall be between C16/20 and C50/60 according to EN 206-1. Due to the lack of availability of the European standard EN 206-1, alternatively a concrete according to national rules, applicable at the place of use, with a compressive strength which fits in the interval given above, is also considered as appropriate.
- The walls on both sides shall either be plastered/rendered or at least the joints on both sides shall be sealed with plastering/rendering mortar. The mortar for plastering/rendering or sealing shall be based on inorganic aggregates, gypsum, cement or lime or on suitable combinations of these three binders.
- The walls are exposed to fire on one side only.

Fire resistance REI [minutes]	Minimum thickness of the concrete core [mm]
30	100
60	120
60	130
60	140
90	150
90	160
120	≥ 170

## 2.2.4 Essential Requirement 3: Hygiene, health and the environment

### 2.2.4.1 Release of dangerous substances

According to the manufacturer's declaration the shuttering block "THERMOSPAN" taking account of the EU database<sup>9</sup> does not contain any dangerous substances.<sup>10</sup>

### 2.2.4.2 Water vapour permeability

Going out from tests according to EN 12086 for the density of 500 kg/m<sup>3</sup> for the whole range of density in this ETA  $\mu = 2$  for the wet state and  $\mu = 8$  for the dry state of wood-chips aggregate concrete shall be assumed.

Using these values to verify the annual moisture balance or the maximum amount of interstitial condensation according to EN ISO 13788 will be on the safe side.

<sup>9</sup> Notes are stated in Guidance Paper H: "A harmonized approach relating to dangerous substances under the Construction Products Directive", Brussels, 18 February 2000

<sup>10</sup> In addition to the specific clauses relating to dangerous substances contained in this European technical approval, there may be other requirements applicable to the products falling within its scope (e.g. transposed European legislation and national laws, regulations and administrative provisions). In order to meet the provisions of the EC Construction Products Directive, these requirements need also to be complied with, when and where they apply.

The values for the water vapour diffusion resistance of concrete in dependence of density and type and of the different inserts of insulating material are tabulated in EN ISO 10456.

2.2.5 Essential Requirement 4: Safety in use

2.2.5.1 Bond strength between the shuttering leaves and the concrete core

The bond strength is at least equal to the resisting concrete pressure of the shuttering blocks according to chapter 2.2.5.2.

The requirements according to ETAG 009, chapter 6.4.1.3 are met satisfactorily.

2.2.5.2 Resistance to concrete pressure

The fitness for the intended use in relation to resistance to concrete pressure has been determined by testing according to EN 15498, Annex B and C (Determination of tensile strength of web and Determination of flexural strength of shells) of most types of shuttering blocks. In all cases the determined resisting concrete pressure of the shuttering blocks was higher than the pressure of fresh concrete measured in a trial structure of 2 m height. The concreting rate was 8 m/h and the flow class of fresh concrete was F4.

The requirements according to ETAG 009, chapter 6.4.2 are met satisfactorily.

2.2.5.3 Safety against personal injury by contact

As delivered on site the shuttering blocks do not have sharp or cutting edges even if they are curtailed at door or window openings.

Since there is a certain risk of abrasion or of cutting people due to of the rough surfaces of the shuttering blocks handling on site shall be done with gloves.

The requirements according to ETAG 009, chapter 6.4.3 are met satisfactorily.

2.2.6 Essential Requirement 5: Protection against noise

2.2.6.1 Airborne sound Insulation

The rated value of sound insulation according to EN ISO 140-3 for walls made with shuttering blocks "Thermospan 18/12" (see Annex 1) is  $R_w = 60 (-2; -6)$  dB. The value is valid for the following wall section:

- 2,3 cm lime-cement plaster (density 1890 kg/m<sup>3</sup>)
- 18 cm shuttering blocks "Thermospan 18/12" filled with concrete (density 2480 kg m<sup>3</sup>)
- 2,0 cm lime-cement plaster (density 1840 kg/m<sup>3</sup>)

For walls made of thinner shuttering blocks, shuttering blocks with inserts of thermal insulation, walls with shuttering blocks "Thermospan 18/12" with thinner finishes or concrete and finishes of arbitrarily smaller densities the "No performance determined" option in ETAG 009, table 3 is used.

2.2.6.2 Sound absorption

The "No performance determined" option in ETAG 009, table 3 is used.

2.2.7 Essential Requirement 6: Energy economy and heat retention

2.2.7.1 Thermal resistance

The nominal value of the thermal conductivity  $\lambda_D$  of wood-chips aggregate concrete has been determined in the same manner as for the insulating materials according to European standards (e.g. EN 13163, chapter 4.2.1) and in dependence of density are given in the following table:

Density $\rho_{tr}$ [kg/m <sup>3</sup> ]	Thermal conductivity $\lambda_D$ [W/(m*K)]
500	0.13
600	0.15

From this values the thermal resistance  $R_D$  of the shuttering leaves shall be determined by

$$R_D = (t_{s1} + t_{s2}) / \lambda_D \quad [m^2 \cdot K / W]$$

where by  $t_{s1}$  and  $t_{s2}$  are the thicknesses of the outer and inner shuttering leaf.

Walls made of shuttering blocks are slightly inhomogeneous. The reason for inhomogeneous layers according to EN ISO 6946 are due to a vertical and horizontal centre distance of 20 cm to 25 cm uniformly distributed webs, which form the gaps in the grid of the concrete core if the shuttering blocks would be removed. The thermal resistance of this type of shuttering block wall may be determined according to three methods:

First method:

Determination without considering the webs that means as a homogeneous-layered wall according to EN ISO 6946, chapter 6.1, consisting of three layers:

- wood-chips aggregate concrete leaf at the outside of the wall
- concrete core
- wood-chips aggregate concrete leaf at the inside of the wall

This will lead to the minimum value for the thermal resistance.

Second method:

Considering the wall as a thermal inhomogeneous building component with thermal homogeneous and inhomogeneous layers parallel to the surface of the wall according to EN ISO 6946, chapter 6.2. For simplification it is possible to smear the horizontal connection between the vertical columns of the concrete core over the height of the shuttering block (see the following Fig.).

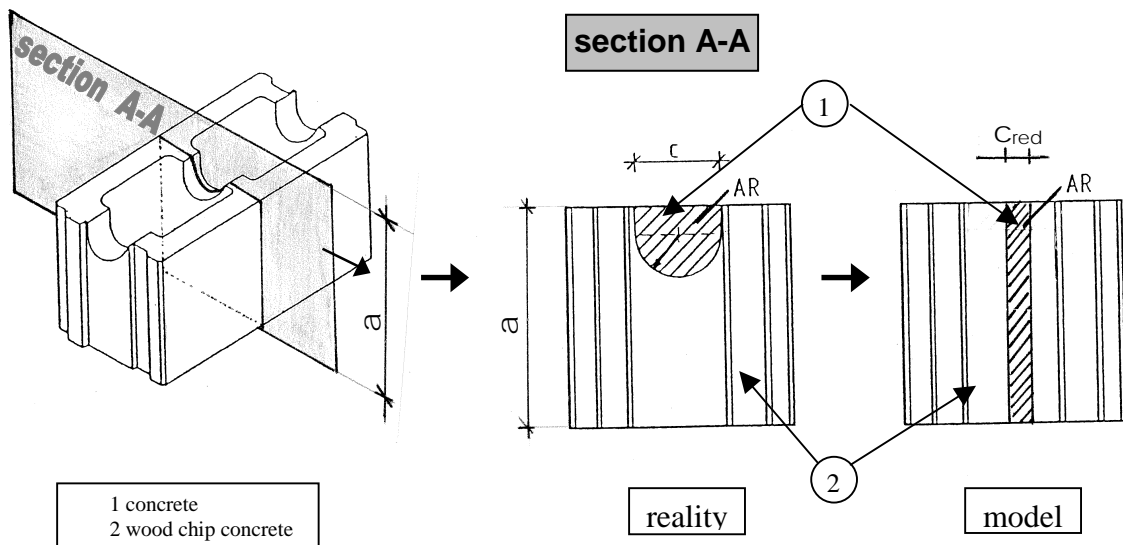

In case of shuttering blocks with inserts of insulating material, at least the second method is to be used.

Third method:

Determination by exact calculation methods according to ISO 10211.

### 2.2.7.2 Thermal inertia

The heat capacity of wood-chips aggregate concrete can be assumed to be equal to concrete with light aggregates in EN ISO 10456, table 4.



The values for the heat capacity of concrete, mineral wool, expanded polystyrene, extruded polystyrene foam, polyurethane foam and expanded cork are also tabulated in EN ISO 10456.

## 2.2.8 Aspects of durability and serviceability

### 2.2.8.1 Resistance to deterioration

#### Physical agent

Since the thermal expansion coefficient of wood-chips aggregate concrete is not higher than of normal weight concrete the dimensions of the shuttering blocks do not differ more than 0.07 % after exposing them for 48 h at 70 °C.

The requirements according to ETAG 009, chapter 6.7.1.1 are met satisfactorily.

#### Chemical agent

The shuttering blocks contain no steel parts where corrosion could occur.

Therefore the requirement "corrosion protection" according to ETAG 009, chapter 6.7.1.2 is met satisfactorily.

#### Biological agent

If the walls are protected by standard finishes and the conditions of use of the building are considered, the application of wood-chips aggregate concrete as thermal insulating material has shown for decades that it sufficiently protects against fungi, bacteria, algae and insects.

Wood-chips aggregate concrete and the used thermal insulating materials do not provide a food value and in general it does not contain voids suitable for habitation by vermin.

The requirements according to ETAG 009, chapter 6.7.1.3 are met satisfactorily.

### 2.2.8.2 Resistance to normal use damage

#### Incorporation of ducts

The instructions in the installation guide of the ETA holder are appropriate to install horizontally passing ducts on site.

#### Fixing of objects

Fixing of objects in the shuttering leaves is not possible; the part of fixings which is significant for the mechanical resistance shall be in the concrete core.

## 3 Evaluation and attestation of conformity and CE marking

### 3.1 System of attestation of conformity

According to the Decision 98/279/EC of 5 December 1997<sup>11</sup> amended by the decision 2001/596/EC of the European Commission<sup>12</sup> system 2+ of the attestation of conformity applies.

This system of attestation of conformity is defined as follows:

System 2+: Declaration of conformity of the product by the manufacturer on the basis of:

(a) Tasks for the manufacturer:

- (1) initial type-testing of the product;
- (2) factory production control;
- (3) testing of samples taken at the factory in accordance with a prescribed test plan.

---

<sup>11</sup> Official Journal of the European Communities L /127 of 24. April 1998

<sup>12</sup> Official Journal of the European Communities L /209 of 8. January 2001

- (b) Tasks for the approved body:
  - (4) certification of factory production control on the basis of:
    - initial inspection of factory and of factory production control;
    - continuous surveillance, assessment and approval of factory production control.

In addition, according to the Decision 2001/596/EC of the European Commission<sup>13</sup> system 1 of the attestation of conformity apply with regard to reaction to fire.

This system of attestation of conformity is defined as follows:

System 1: Certification of the conformity of the product by an approved certification body on the basis of:

- (a) Tasks for the manufacturer:
  - (1) factory production control;
  - (2) further testing of samples taken at the factory by the manufacturer in accordance with a prescribed test plan;
- (b) Tasks for the approved body:
  - (3) initial type-testing of the product;
  - (4) initial inspection of factory and of factory production control;
  - (5) continuous surveillance, assessment and approval of factory production control.

Note: Approved bodies are also referred to as "notified bodies".

## 3.2 Responsibilities

### 3.2.1 Tasks for the manufacturer

#### 3.2.1.1 Factory production control

The manufacturer shall exercise permanent internal control of production. All the elements, requirements and provisions adopted by the manufacturer shall be documented in a systematic manner in the form of written policies and procedures, including records of results performed. This production control system shall insure that the product is in conformity with this European technical approval.

The manufacturer may only use raw materials stated in the technical documentation of this European technical approval.

The factory production control shall be in accordance with the control plan which is part of the technical documentation of this European technical approval. The control plan is laid down in the context of the factory production control system operated by the manufacturer and deposited at Deutsches Institut für Bautechnik.<sup>14</sup>

The results of factory production control shall be recorded and evaluated in accordance with the provisions of the control plan.

#### 3.2.1.2 Other tasks of manufacturer

The manufacturer shall, on the basis of a contract, involve a body which is approved for the tasks referred to in section 3.1 in the field of non-load bearing shuttering systems in order to undertake the actions lay down in section 3.2.2. For this purpose, the control plan referred to in sections 3.2.1.1 and 3.2.2 shall be handed over by the manufacturer to the approved body involved.

The manufacturer shall make a declaration of conformity, stating that the construction product is in conformity with the provisions of this European technical approval.

---

<sup>13</sup> Official Journal of the European Communities L 209/33 of 2. August 2001

<sup>14</sup> The control plan is a confidential part of the documentation of the European technical approval, but not published together with the ETA and only handed over to the approved body involved in the procedure of attestation of conformity, see section 3.2.2.

### 3.2.2 Tasks for the approved bodies

The approved body shall perform the

- initial type-testing of the product (only for reaction to fire),
  - initial inspection of factory and of factory production control,
  - continuous surveillance, assessment and approval of factory production control,
- in accordance with the provisions laid down in the control plan.

The frequency of the inspections by the approved bodies shall be performed in accordance with control plan.

The approved body shall retain the essential points of its actions referred to above and state the results obtained and conclusions drawn in a written report.

The approved certification body involved by the manufacturer shall issue an EC certificate of conformity of the product stating the conformity with the provisions of this European technical approval (only for reaction to fire).

The approved certification body involved by the manufacturer shall issue an EC certificate of conformity of the factory production control stating the conformity with the provisions of this European technical approval.

In cases where the provisions of the European technical approval and its control plan are no longer fulfilled the certification body shall withdraw the certificate of conformity and inform Deutsches Institut für Bautechnik without delay.

### 3.3 CE marking

The CE marking shall always be affixed on packing and on the accompanying commercial documents. The letters "CE" shall be followed by the identification number of the approved certification body, and be accompanied by the following additional information:

- the name and address of the producer (legal entity responsible for the manufacture),
- the last two digits of the year in which the CE marking was affixed,
- the number of the EC certificate of conformity for the product (only for reaction to fire),
- the number of the EC certificate for the factory production control,
- the number of the European technical approval ETA-05/0262,
- the number of the guideline ETAG 009 for European technical approval,
- Reaction to fire: Class according to EN 13501-1 (see 2.2.3.1),
- Resistance to fire: Class according to EN 13501-2 in dependence of minimum thickness of the concrete core (see 2.2.3.2),
- Protection against noise "No performance determined",
- designation code of the insulating material (see table 2),
- the nominal value of thermal resistance  $R_D$  of the used wood-chips aggregate concrete according to EN 13163, chapter 4.2.1 (see section 2.2.7.1).

## **4 Assumptions under which the fitness of the product for the intended use was favourably assessed**

### **4.1 Manufacturing**

The European technical approval is issued for the product on the basis of agreed data/information, deposited with Deutsches Institut für Bautechnik, which identifies the product that has been assessed and judged. Changes to the product or production process, which could result in this deposited data/information being incorrect, should be notified to Deutsches Institut für Bautechnik before the changes are introduced. Deutsches Institut für Bautechnik will decide whether or not such changes affect the approval and consequently the validity of the CE marking on the basis of the approval and if so whether further assessment or alterations to the approval shall be necessary.

### **4.2 Installation**

#### **4.2.1 General**

The manufacturer shall ensure that the requirements in accordance with sections 1, 2, and 4 are made known to those involved in planning and execution. The installation guide is deposited at DIBt and shall be present at every construction site. If the manufacturer's instructions contain other specifications than those stated here, the specifications of the ETA shall apply.

After installation of the shuttering blocks (see section 4.2.2) the site-mixed or ready mixed concrete is brought in and compacted.

In end use conditions concrete walls of grid type<sup>15</sup> of plain or reinforced concrete according to EN 1992-1-1 or corresponding national rules will be formed.

For structural design dimension and weights given in Annex 4 have to be used.

In end use conditions the wood-chips aggregate concrete leaves of the shuttering blocks and the strips of insulating material are the main part of the thermal insulation of the walls.

#### **4.2.2 Installation of the shuttering blocks**

The shuttering blocks are put together on site in layers without adhesive. To receive stable floor high formworks the vertical joints between two blocks of one layer have to be shifted up to half of the block length to the vertical joints of the previous and next layer (see Annex 3), so that the middle planes of the webs of the shuttering blocks placed on top of each other form vertical planes.

First of all one layer of shuttering blocks shall be laid exactly according to the planned elevation and alignment for the entire floor plan.

Subsequently, according to the installation guide of the manufacturer, the shuttering blocks are to be stacked in bond (see Annex 3) to floor height. Thereby the necessary reinforcement also shall be installed according to the installation guide.

Rectangular wall corners are to be formed according to Annex 3. The lintel shutterings shall be supported.

The erection of the storey high shuttering elements shall be performed in accordance to the manual of the manufacturer.

---

15 see ETAG 009, chapter 2.2

#### 4.2.3 Installation of the reinforcement

In general only plain concrete walls can be realised with this systems. According to the installation guide it is possible to install reinforcement as following:

- in every horizontal connection between the vertical columns of the grid
- in every vertical column one single reinforcement bar, a reinforcing steel mesh or a reinforcement cage for the whole column

The preconditions for the installation of reinforcement are:

- The horizontal dimensions of reinforcing steel meshes or cages for the vertical reinforcement including spacers shall be appropriately smaller than the corresponding minimum dimensions of the concrete core
- Planning shall allow sufficient spaces in the reinforcement for discharge pipes or concreting tubes.
- The resistance of the wood-chips aggregate concrete to carbonisation and to chloride penetration has not been examined, i.e., the full concrete cover according to EN 1992-1-1 or corresponding national rules shall be applied.
- The minimum and maximum distance between reinforcing bars shall be in accordance with EN 1992-1-1 or corresponding national rules.
- If more than one bar is installed as vertical reinforcement all the bars shall be joined to a mesh (e.g. by welded or knotted-on cross bars).

The lintels in every case have to be reinforced as beams according to EN 1992-1-1 or corresponding national rules.

#### 4.2.4 Concreting

For the production of normal concrete EN 206-1 shall apply. Concrete within and below the lower flow class range F3 shall be compacted by shaking. Concrete within and above the upper flow class range F3 sufficiently can be compacted by poking. The flow class of fresh concrete shall not be higher than F5 and depending on the thickness of the concrete core not lower than given in ETAG 009, sub-clause 7.2.2. The maximum aggregate sizes depending on the thickness of the concrete core shall not be higher than given in ETAG 009, sub-clause 7.2.2. The concrete shall have rapid or middle strength development according to EN 206-1, table 12.

Placing the concrete shall be performed only by persons who were instructed in the works and in the proper handling of the shuttering system. To allow safe handling, independent self-supporting carrying scaffolding is necessary.

The maximum filling rate shall not exceed 3 m/h. The concrete shall be placed in layers of approximately 1 m.

If equivalent national rules are not available, the following instructions shall be considered:

Horizontal day joints are to be arranged preferably at the height of the floor. In the case these cannot be achieved vertical connection reinforcement bars have to be installed. The connection reinforcement shall fulfil the following requirements:

- two adjacent vertical connection reinforcement bars shall not be situated in the same plane parallel to the surface of the wall,
- the distance between two connection reinforcement bars in wall direction shall be at least 10 cm and not larger than 50 cm,
- the total section area of the connection reinforcement bars shall not be smaller than 1/2000 of the section area of the concrete core,
- anchorage length of the connection reinforcement bars on both sides of the day joint shall at least be 20 cm

Before further placing of concrete, cement laitance and detached / loose concrete shall be removed and the day joints shall be sufficiently pre-wetted. At the time of concreting the surface of the older concrete shall be slightly moist, so that the cement paste of the newly brought in concrete can combine well with the older concrete.

If no day joint is planned, placing of concrete in layers may only be interrupted as long as the brought in concrete is not yet solidified so that a good and even bond is still possible between the two concrete layers. When using internal vibrators, the vibrating cylinder shall still penetrate into the already compressed lower concrete layer.

The concrete may fall freely only up to a height of 2 m, beyond that the concrete shall be poured through discharge pipes or concreting tubes with a maximum diameter of 100 mm and shall be led immediately to the place of installation.

Pouring cones are to be avoided by short distances between the places of fill in.

After concreting the walls may not deviate from the plumb line more than 5 mm per running meter wall height.

The ceiling may only be placed on walls made of shuttering blocks if a sufficient strength of the infill concrete exists.

#### 4.2.5 Ducts crossing and lying in the wall

Horizontally passing ducts are to be installed according to the installation guide of the ETA holder and are to be taken into account when designing the wall.

Horizontal ducts lying in the wall cores are to be avoided. If absolutely necessary, these are to be taken into account when designing the wall.

Also vertical ducts in the concrete core shall be considered, if their diameter exceeds 1/6 of the thickness of the concrete core and the distance of the pipes is less than 2 m.

#### 4.2.6 Reworking and finishes

Walls of the type "THERMOSPAN" are to be protected by finishes. Finishes are not part of the kit and therefore not considered in this ETA. For external surfaces preferably the used rendering systems should meet the requirement of ETAG 004. The execution of the rendering shall be performed according to applicable national rules.

Before rendering the roof of the building shall be closed and the surfaces of the walls shall be free from soiling.

#### 4.2.7 Fixing of objects

Fixing of objects in the shuttering leaves is not possible; the part of fixings which is significant for the mechanical resistance shall be in the concrete. The influence of the fixing to the reduction of the thermal resistance has to be considered according to EN ISO 6946.

## 5 Indications to the manufacturer

### 5.1 Packaging, transport and storage

The shuttering blocks have to be protected against damage.

### 5.2 Use, maintenance, repair

Regular checks should be carried out on render finishes to ensure that any damage is detected and repaired as soon as possible.

Concerning recommendations on use, maintenance and repair ETAG 009, section 7.5 shall apply.

Georg Feistel  
Head of Department

*beglaubigt*  
Schwab

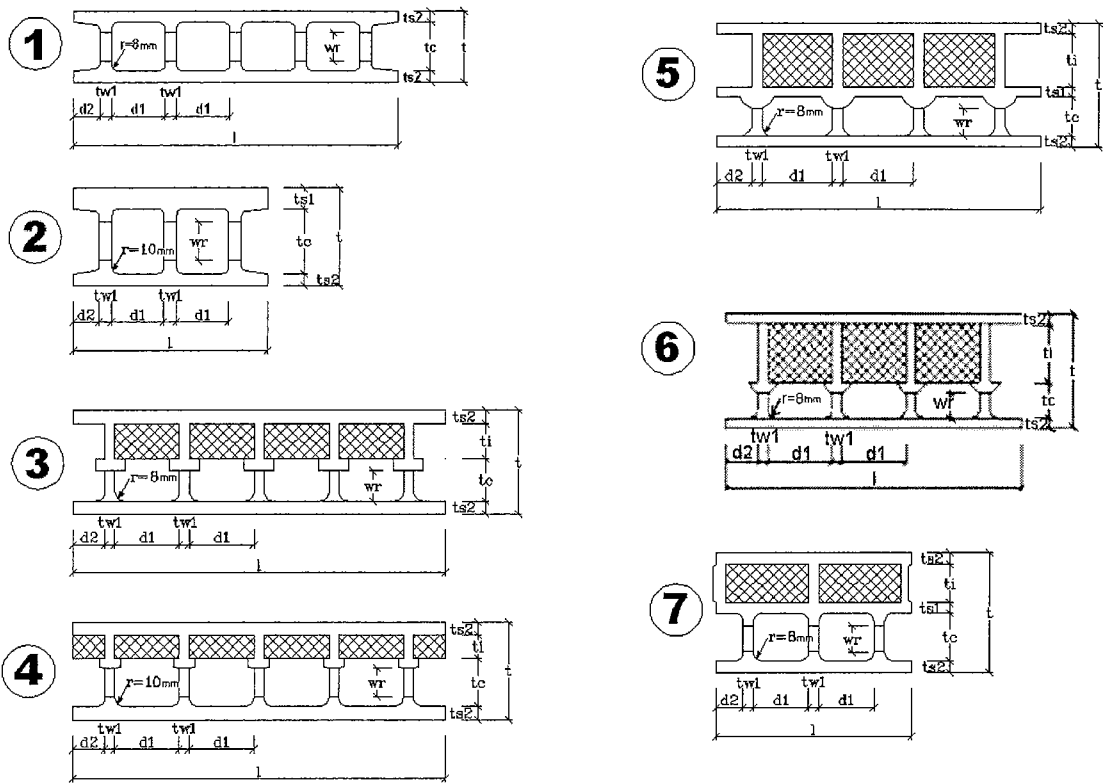

Type	Fig.	l	t	d <sub>1</sub>	d <sub>2</sub>	tw <sub>1</sub>	ts <sub>2</sub>	ts <sub>1</sub>	tc	wr	ti
		cm	cm	cm	cm	cm	cm	cm	cm	cm	cm
15/9*	1	110	15	18.7	9.35	3.3	3	-	9	7.5	-
18/12*	1	100	18	16.7	8.35	3.3	3	-	12	9	-
20/13*	1	100	20	21.5	10.75	3.5	3.5	-	13	9	-
22/15*	1	100	22	16.5	8.25	3.5	3.5	-	15	9	-
25/19*	1	100	25	16.7	8.35	3.3	3.2	-	18.6	12	-
25/16*	1	100	25	16.2	8.1	3.8	4.5	-	16	12	-
30/22*	1	100	30	16	8	4	4.1	-	21.8	12	-
30/20*	2	60	30	16	8	4	3.7	6.3	20	12	-
S 25/6	3	115	25	20	10	3	3.5	-	12	8	6
S 30/10	3	115	30	20	10	3	3.5	-	13	8	10
S 32/11	3	115	32	20	10	3	4	-	13	8	11
S 30/7	4	115	30	20	10	3	4	-	15	12	7
S 30/8	4	115	30	20	10	3	4	-	14	12	8
S 38/16	5	100	38	21.7	10.85	3.3	3.2	3.2	12	8	16.4
S 38/19	6	100	38	18.6	10.85	6.4	3.2	-	12	7.5	19
T 38/16	7	60.5	38	16.86	8.43	3.3	3.2	3	12.2	8	16.4

see 2.2.3.1

<b>THERMOSPAN – shuttering blocks</b>	<b>Annex 1</b> of European technical approval ETA-05/0262
normal blocks	

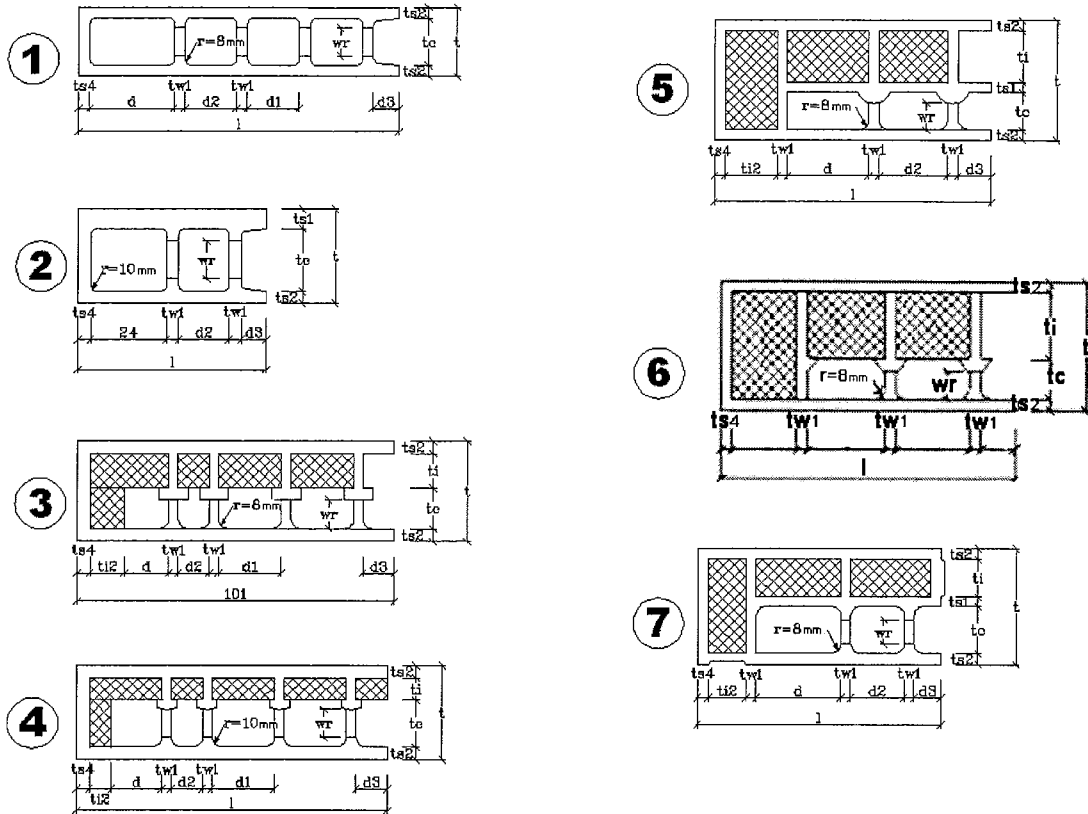

Type	Fig.	l	t	d	d <sub>2</sub>	d <sub>1</sub>	d <sub>3</sub>	tw <sub>1</sub>	ts <sub>4</sub>	ts <sub>2</sub>	ts <sub>1</sub>	tc	wr	ti	ti <sub>2</sub>
		cm	cm	cm	cm	cm	cm	cm	cm	cm	cm	cm	cm	cm	cm
15/9*	1	101	15	21.05	18.7	18.7	7.35	3.3	3.3	3	-	9	7.5	-	-
18/12*	1	98	18	23.05	16.7	16.7	8.35	3.3	3.3	3	-	12	9	-	-
20/13*	1	95	20	27.25	21.5	21.5	10.75	3.5	3.5	3.5	-	13	9	-	-
22/15*	1	102	22	26.75	16.5	16.5	8.25	3.5	3.5	3.5	-	15	9	-	-
25/19*	1	105	25	30.05	16.7	16.7	8.35	3.3	3.3	3.2	-	18.6	12	-	-
25/16*	1	105	25	28.6	16.2	16.2	8.1	3.8	4.5	4.5	-	16	12	-	-
30/22*	1	90	30	20	10	16	8	4	4	4.1	-	21.8	12	-	-
30/20*	2	60	30	24	16	-	8	4	4	3.7	6.3	20	12	-	-
S 25/6	3	95	25	13	10	20	10	3	4	3.5	-	12	8	6	6
S 30/10	3	99	30	13	10	20	10	3	4	3.5	-	13	8	10	10
S 32/11	3	101	32	14	10	20	10	3	4	4	-	13	8	11	11
S 30/7	4	99	30	16	10	20	10	3	4	4	-	15	12	7	7
S 30/8	4	99	30	15	10	20	10	3	4	4	-	14	12	8	8
S 38/16	5	88	38	22.85	21.7	-	10.85	3.3	3.3	3.2	3.2	12	8	16.4	16.4
S 38/19	6	88	38	22.85	21.7	-	10.85	6.4	3.3	3.2	-	12	7.5	19	19.4
T 38/16	7	78.3	38	23.6	16.9	-	8.43	3.3	3.5	3.2	3	12	8	16.4	16.4

\* see 2.2.3.1

**THERMOSPAN – shuttering blocks**

stopper blocks

**Annex 2**

of European  
 technical approval  
 ETA-05/0262



**Structure of layer on wall corner – types 15/9, 18/12, 20/13, 22/15, 25/19, 25/16, 30/22, 30/20**

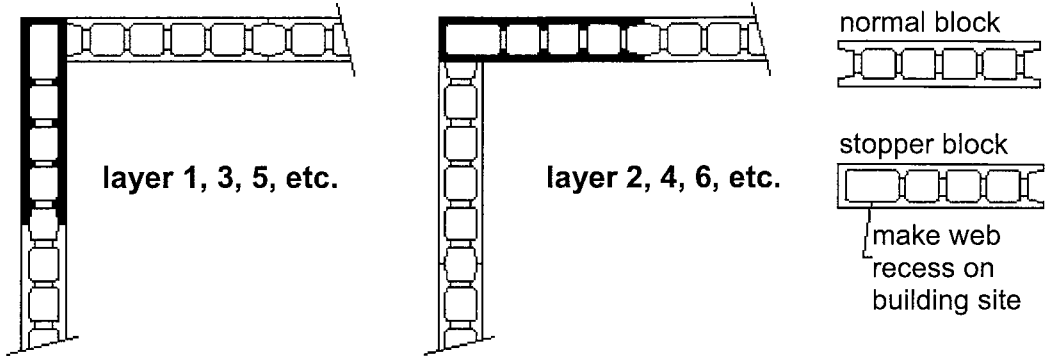

**Structure of layer on wall corner – types S 25/6, S 30/10, S 32/11, S 30/7, S 30/8, S 38/16, S 38/19**

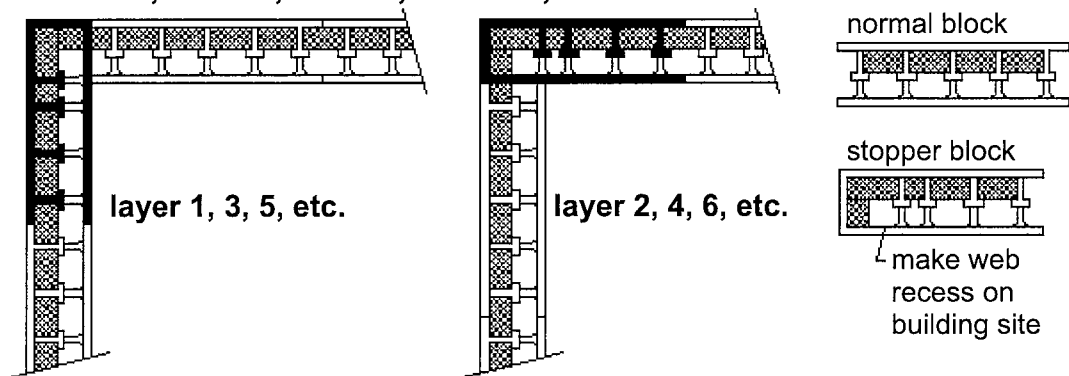

**Structure of layer on wall corner – types T 38/16**

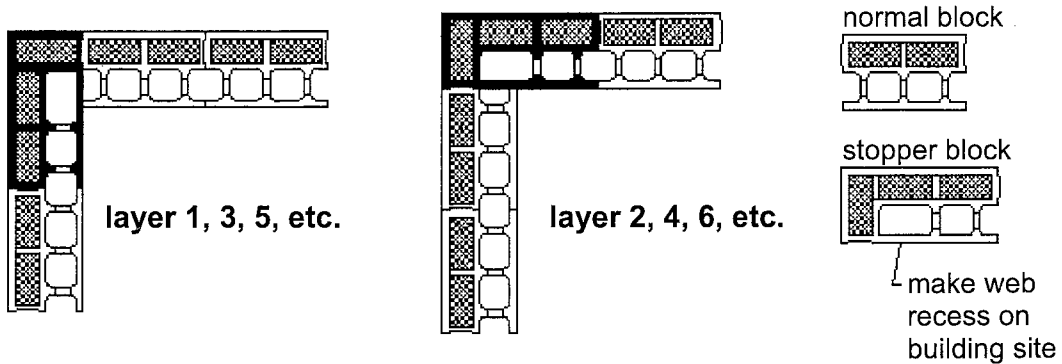

**THERMOSPAN – shuttering blocks**

bond on wall corners of different types of shuttering blocks

**Annex 3**

of European  
 technical approval  
 ETA-05/0262

Type	to Annex/ Fig.	wall thickness	core thickness	web recess area per unit	core area		volume of concrete infill	calculation weight of the	
					displaced 20 cm to 25 cm	one upon other		shuttering element	wall without rendering <sup>(1)</sup>
		cm	cm	cm <sup>2</sup>	cm <sup>2</sup> /m	cm <sup>2</sup> /m	m <sup>3</sup> /m <sup>2</sup>	kN/m <sup>2</sup>	kN/m <sup>2</sup>
<b>shuttering blocks of wood chip aggregate concrete <math>\rho_{tr} \leq 500 \text{ kg/m}^3</math></b>									
15/9	T1/1	15	9	70	Non-load bearing		0.073	0.518	2.060
18/12	T1/1	18	12	75	1002	1002	0.100	0.574	2.670
20/13	T1/1	20	13	75	1118	1118	0.113	0.615	2.900
22/15	T1/1	22	15	75	1237	1237	0.120	0.624	3.260
25/16	T1/1	25	16	95	1296	1296	0.132	0.780	3.600
30/22	T1/1	30	21.8	110	1744	1744	0.183	0.820	4.660
30/20	T1/2	30	20	100	1488	1488	0.163	1.005	4.420
S 25/6	T1/3	25	12	70	1024	1024	0.093	0.740	2.690
S 30/10	T1/3	30	13	70	955	955	0.970	0.777	2.810
S 32/11	T1/3	32	13	70	935	935	0.095	0.814	2.960
S 30/7	T1/4	30	15	95	1285	1285	0.125	0.777	3.350
S 30/8	T1/4	30	14	95	1198	1198	0.118	0.777	3.260
S 38/16	T1/5	38	12	70	950	950	0.093	0.882	2.850
S 38/19	T1/6	38	12	70	756	950	0.093	0.882	2.850
T 38/16	T1/7	38	12	70	1021	1021	0.102	0.882	2.850
<b>shuttering blocks of wood chip aggregate concrete <math>\rho_{tr} \leq 600 \text{ kg/m}^3</math></b>									
25/19	T1/1	25	18.6	95	1553	1553	0.153	0.741	3.950

<sup>(1)</sup> Assumed concrete density = 23 kN/m<sup>3</sup>

<b>THERMOSPAN – shuttering blocks</b>	<b>Annex 4</b> of European technical approval ETA-05/0262
sections, volumes and weights	

**corner element**

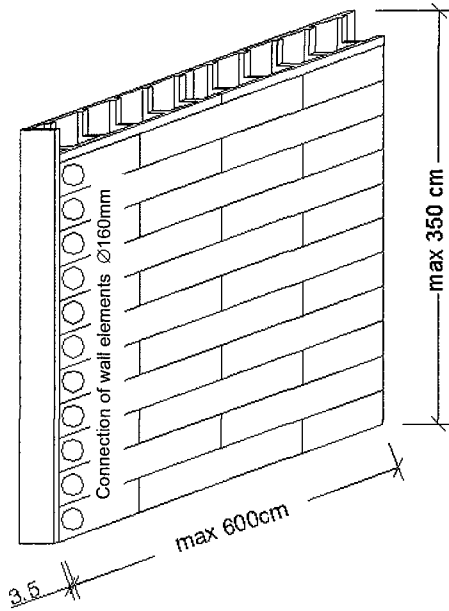

**normal element**

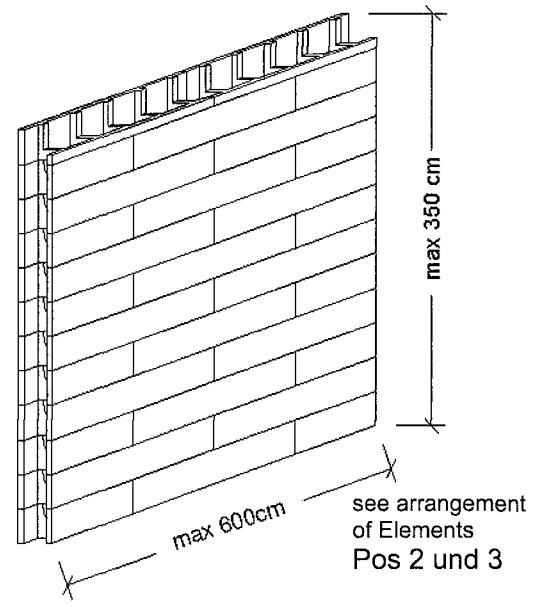

**lintel element**

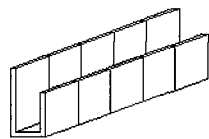

see arrangement  
of Elements  
Pos S1

**parapet element**

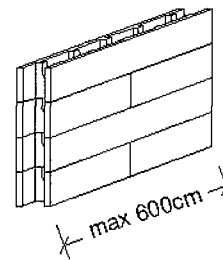

see arrangement  
of Elements  
Pos 1

**THERMOSPAN – shuttering blocks**

wall elements

**Annex 5**

of European  
technical approval  
ETA-05/0262

## wall elements - types

arrangement plan – type 1

edges of the ceiling

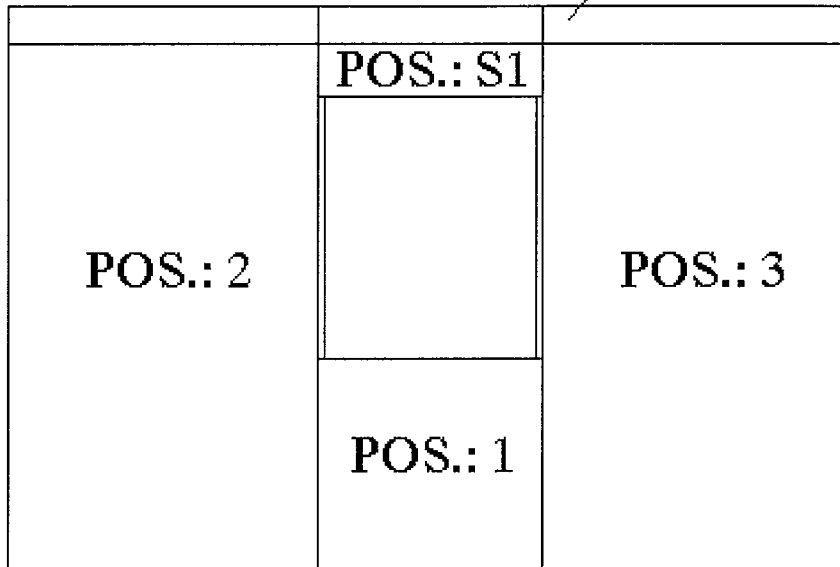

arrangement plan – type 2

edges of the ceiling

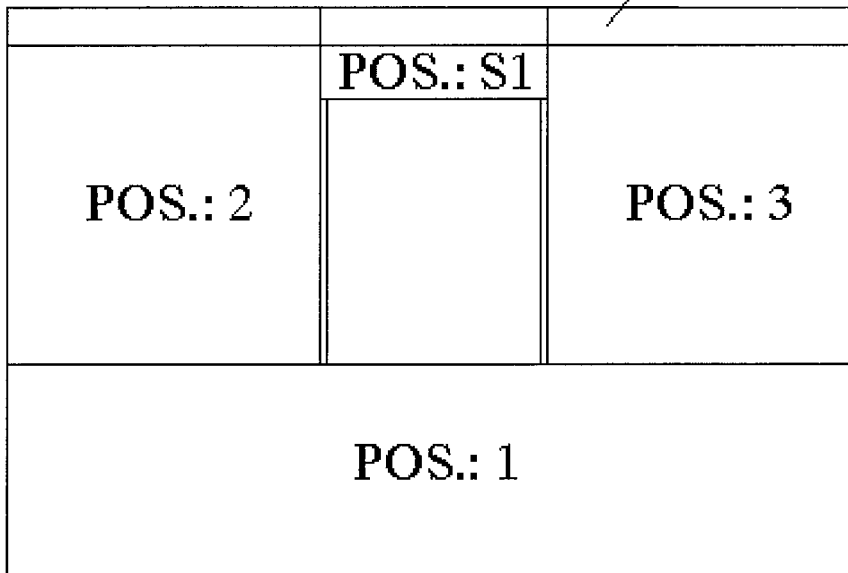

**THERMOSPAN – shuttering blocks**

**Annex 6**

wall elements  
 basic arrangement plan – types

of European  
 technical approval  
 ETA-05/0262

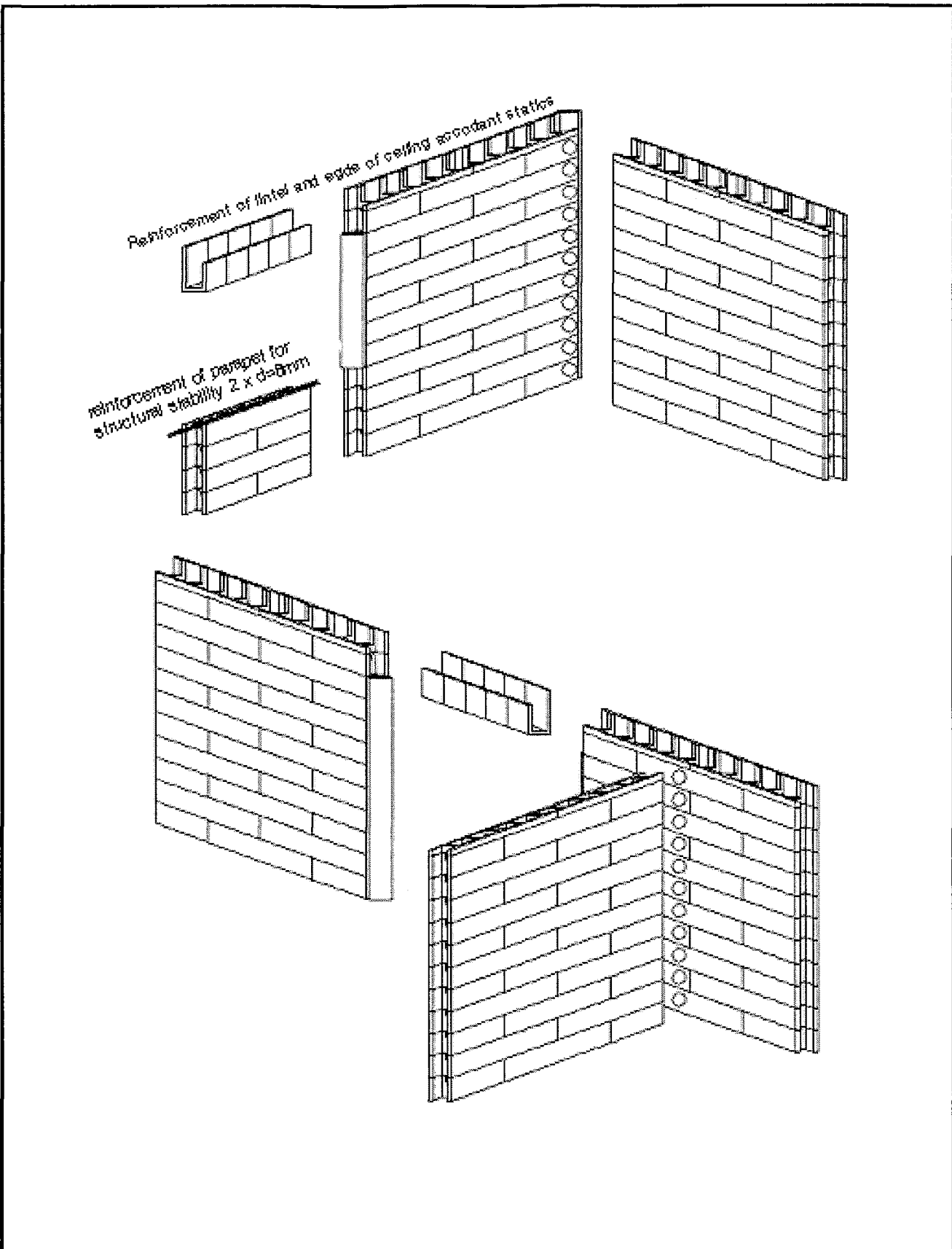

<b>THERMOSPAN – shuttering blocks</b>	<b>Annex 7</b>
wall elements 3D-example of arrangement plan – type 1	of European technical approval ETA-05/0262

## horizontal cross section

horizontal reinforcement (in case of more than five full floors)

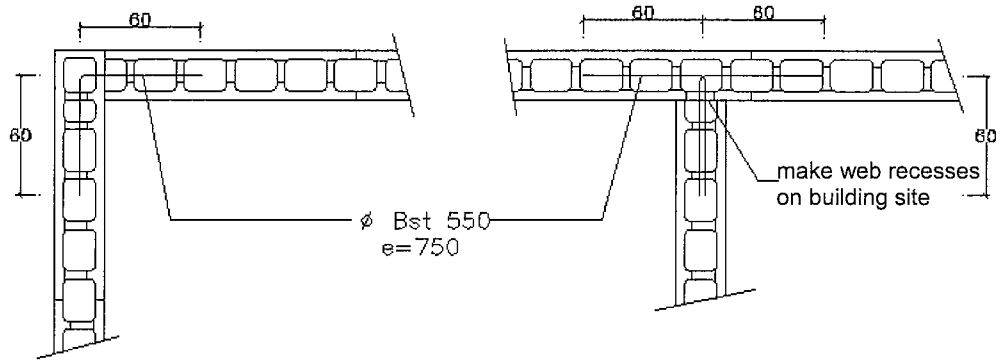

## vertical cross section

ceiling supports

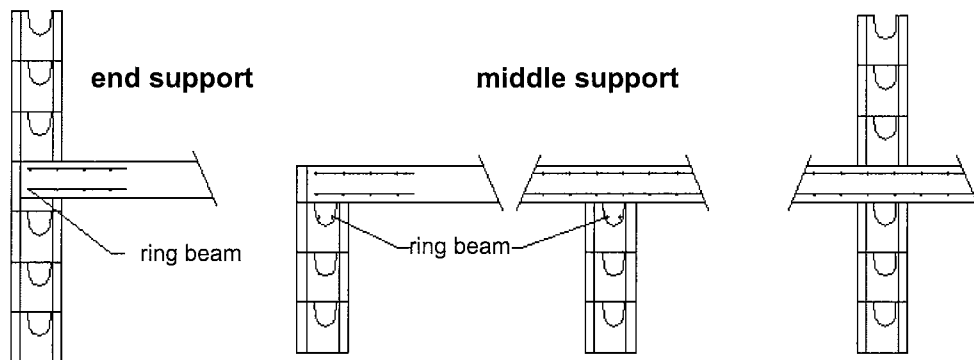

dimensions in mm

<b>THERMOSPAN – shuttering blocks</b>	<b>Annex 8</b> of European technical approval ETA-05/0262
details of horizontal reinforcement and of ceiling supports	

<b>standards and guidelines</b>	<b>issue</b>	<b>title</b>	
EN	206-1	2000	Concrete – Part 1: Specification, performance, production and conformity
EN	1992-1-1	2004	Eurocode 2: Design of concrete structures. – Part 1-1: General rules and rules for buildings
EN	12086	1997	Thermal insulating products for building applications – Determination of water vapour transmission properties
EN	13162	2001	Thermal insulation products for buildings – Factory made mineral wool (MW) products – Specification
EN	13163	2001	Thermal insulation products for buildings – Factory made products of expanded polystyrene (EPS) – Specification
EN	13164	2001	Thermal insulation products for buildings – Factory made products of extruded polystyrene foam (XPS) – Specification
EN	13165	2001	Thermal insulation products for buildings – Factory made rigid polyurethane foam (PUR) products – Specification
EN	13170	2001	Thermal insulation products for buildings – Factory made products of expanded cork (ICB) – Specification
EN	15498	2008	Precast concrete products – Wood-chip concrete shuttering blocks – Product properties and performance
EN	13501-1	2007	Fire classification of construction products and building elements – Part 1: Classification using test data from reaction to fire tests
EN	13501-2	2003	Fire classification of construction products and building elements – Part 2: Classification using data from fire resistance tests, excluding ventilation services
EN ISO	140-3	2004	Acoustics – Measurement of sound insulation in buildings and of building elements. – Part 3: Laboratory measurements of airborne sound insulation of building elements
EN ISO	6946	2007	Building components and building elements – Thermal resistance and thermal transmittance – Calculation method
EN ISO	10456	2007	Building materials and products – Hygrothermal properties – Tabulated design values and procedures for determining declared and design thermal values
EN ISO	13788	2001	Hygrothermal performance of building components and building elements – Internal surface temperature to avoid critical surface humidity and interstitial condensation – Calculation methods
ETAG	004	2000-03	Guideline for European technical approval of "External thermal insulation composite systems with rendering"
ETAG	009	2002-06	Guideline for European technical approval of "Non load bearing permanent shuttering kits/systems based on hollow blocks or panels of insulating materials and sometimes concrete"

**THERMOSPAN – shuttering blocks**

list of standards and guidelines

**Annex 9**

**of European  
technical approval  
ETA-05/0262**

holder of approval	designation of the manufacturing plant on the ETA covering page	manufacturing plant
Thermospan	T1	thermo-span Baustoffwerk HarmI & Quehenberger GmbH Maschl 28 5600 St. Johann/Pongau Austria
	T2	SAS XELIS Route de La Guerche BP 15 35680 Bais France
<b>THERMOSPAN – shuttering blocks</b>		<b>Annex 10</b> of European technical approval <b>ETA-05/0262</b>
list of manufacturing plants		