

European Technical Approval ETA-12/0306

English translation prepared by DIBt - Original version in German language

Handelsbezeichnung
Trade name

INDEX Injektionssystem MOPOSE
INDEX Injection System MOPOSE

Zulassungsinhaber
Holder of approval

INDEX Técnicas Expansivas S. L.
Segador 13. P.I. La Portalada II
26006 LOGROÑO-ESPAÑA
SPANIEN

Zulassungsgegenstand
und Verwendungszweck
*Generic type and use
of construction product*

Injektionssystem zur Verankerung im Mauerwerk
Injection system for use in masonry

Geltungsdauer:
Validity:

vom
from
bis
to

23 August 2012
19 January 2017

Herstellwerk
Manufacturing plant

Plant 1

Diese Zulassung umfasst
This Approval contains

17 Seiten einschließlich 9 Anhänge
17 pages including 9 annexes

I LEGAL BASES AND GENERAL CONDITIONS

- 1 This European technical approval is issued by Deutsches Institut für Bautechnik in accordance with:
 - Council Directive 89/106/EEC of 21 December 1988 on the approximation of laws, regulations and administrative provisions of Member States relating to construction products¹, modified by Council Directive 93/68/EEC² and Regulation (EC) N° 1882/2003 of the European Parliament and of the Council³;
 - *Gesetz über das In-Verkehr-Bringen von und den freien Warenverkehr mit Bauprodukten zur Umsetzung der Richtlinie 89/106/EWG des Rates vom 21. Dezember 1988 zur Angleichung der Rechts- und Verwaltungsvorschriften der Mitgliedstaaten über Bauprodukte und anderer Rechtsakte der Europäischen Gemeinschaften (Bauproduktengesetz - BauPG) vom 28. April 1998⁴, as amended by Article 2 of the law of 8 November 2011⁵;*
 - Common Procedural Rules for Requesting, Preparing and the Granting of European technical approvals set out in the Annex to Commission Decision 94/23/EC⁶;
 - Guideline for European technical approval of "Metal Injection Anchors for Use in Masonry", ETAG 029.
- 2 Deutsches Institut für Bautechnik is authorized to check whether the provisions of this European technical approval are met. Checking may take place in the manufacturing plant. Nevertheless, the responsibility for the conformity of the products to the European technical approval and for their fitness for the intended use remains with the holder of the European technical approval.
- 3 This European technical approval is not to be transferred to manufacturers or agents of manufacturers other than those indicated on page 1, or manufacturing plants other than those indicated on page 1 of this European technical approval.
- 4 This European technical approval may be withdrawn by Deutsches Institut für Bautechnik, in particular pursuant to information by the Commission according to Article 5(1) of Council Directive 89/106/EEC.
- 5 Reproduction of this European technical approval including transmission by electronic means shall be in full. However, partial reproduction can be made with the written consent of Deutsches Institut für Bautechnik. In this case partial reproduction has to be designated as such. Texts and drawings of advertising brochures shall not contradict or misuse the European technical approval.
- 6 The European technical approval is issued by the approval body in its official language. This version corresponds fully to the version circulated within EOTA. Translations into other languages have to be designated as such.

¹ Official Journal of the European Communities L 40, 11 February 1989, p. 12

² Official Journal of the European Communities L 220, 30 August 1993, p. 1

³ Official Journal of the European Union L 284, 31 October 2003, p. 25

⁴ *Bundesgesetzblatt Teil I 1998*, p. 812

⁵ *Bundesgesetzblatt Teil I 2011*, p. 2178

⁶ Official Journal of the European Communities L 17, 20 January 1994, p. 34

II SPECIFIC CONDITIONS OF THE EUROPEAN TECHNICAL APPROVAL

1 Definition of product/ products and intended use

1.1 Definition of the construction product

The INDEX Injection system MOPOSE is a bonded anchor (injection type) consisting of a mortar cartridge with INDEX injection mortar MOPOSE, a plastic sieve sleeve and an anchor rod with hexagon nut and washer in the sizes M8, M10 and M12 or internal threaded sockets in sizes M8, M10 and M12. The steel elements are made of zinc coated steel.

The sieve sleeve is pushed into a drilled hole and the chemical mortar is injected into the perforated sleeve in the masonry before the anchor rod or the socket with internal thread is placed in the sieve sleeve. The installation of the anchor rod in solid masonry can be also done without sieve sleeve.

The anchor rod or the socket with internal thread anchored via the bond between steel element, injection mortar and masonry and by mechanical interlock.

An illustration of the product and intended use is given in Annex 1.

1.2 Intended use

The anchor is intended to be used for anchorages for which requirements for mechanical resistance and stability and safety in use in the sense of the Essential Requirements 1 and 4 of Council Directive 89/106 EEC shall be fulfilled and failure of anchorages made with these products would cause risk to human life and/or lead to considerable economic consequences.

The anchor is to be used only for anchorages subject to static or quasi-static loading in solid masonry (use category b), hollow or perforated masonry (use category c) according to Annexes 7 and 8. The mortar strength class of the masonry has to be M 2,5 according to EN 998-2:2010 at minimum.

The anchor may be used in the service temperature range from -40 °C to +80 °C (maximum long term temperature +50 °C and max short term temperature +80 °C).

The anchor may be installed in dry or wet structures and it may only be used in structures subject to dry internal conditions (use categories d/d and w/d).

The provisions made in this European technical approval are based on an assumed working life of the anchor of 50 years. The indications given on the working life cannot be interpreted as a guarantee given by the producer, but are to be regarded only as a means for choosing the right products in relation to the expected economically reasonable working life of the works.

2 Characteristics of the product and methods of verification

2.1 Characteristics of product

The anchor corresponds to the drawings and provisions given in the annexes. The characteristic material values, dimensions and tolerances of the anchor not indicated in annexes shall correspond to the respective values laid down in the technical documentation⁷ of this European technical approval.

⁷ The technical documentation of this European technical approval is deposited at the Deutsches Institut für Bautechnik and, as far as relevant for the tasks of the approved bodies involved in the attestation of conformity procedure, is handed over to the approved bodies.

The two components of the injection mortar are delivered in unmixed condition according to Annex 3. Each internal threaded socket is marked according to Annex 2.

The characteristic anchor values for the design of anchorages are given in Annex 9.

The anchor satisfies the requirements for class A1 of the characteristic reaction to fire. Regarding resistance to fire no performance is determined.

2.2 Methods of verification

The assessment of fitness of the anchor for the intended use in relation to the requirements for mechanical resistance and stability and safety in use in the sense of the Essential Requirements 1 and 4 has been made in accordance with the "Guideline for European technical approval of Metal Injection Anchors for Use in Masonry", ETAG 029, based on the Use Categories b and c in respect of the base material and Category d/d and w/d in respect of installation and use.

In addition to the specific clauses relating to dangerous substances contained in this European technical approval, there may be other requirements applicable to the products falling within its scope (e.g. transposed European legislation and national laws, regulations and administrative provisions). In order to meet the provisions of the Construction Products Directive, these requirements need also to be complied with, when and where they apply.

3 Evaluation and attestation of conformity and CE marking

3.1 System of attestation of conformity

According to the Decision 97/177/EC of the European Commission⁸ System 1 of the attestation of conformity applies.

This system of attestation of conformity is defined as follows:

System 1: Certification of the conformity of the product by an approved certification body on the basis of:

- (a) Tasks for the manufacturer:
 - (1) factory production control;
 - (2) further testing of samples taken at the factory by the manufacturer in accordance with a prescribed test plan;
- (b) Tasks for the approved body:
 - (3) initial type-testing of the product;
 - (4) initial inspection of factory and of factory production control;
 - (5) continuous surveillance, assessment and approval of factory production control.

Note: Approved bodies are also referred to as "notified bodies".

3.2 Responsibilities

3.2.1 Tasks for the manufacturer

3.2.1.1 Factory production control

The manufacturer shall exercise permanent internal control of production. All the elements, requirements and provisions adopted by the manufacturer shall be documented in a systematic manner in the form of written policies and procedures, including records of results performed. This production control system shall insure that the product is in conformity with this European technical approval.

⁸ Official Journal of the European Communities L 073 of 14.03.1997

The manufacturer may only use initial/raw/constituent materials stated in the technical documentation of this European technical approval.

The factory production control shall be in accordance with the control plan⁹ which is part of the technical documentation of this European technical approval. The control plan is laid down in the context of the factory production control system operated by the manufacturer and deposited at Deutsches Institut für Bautechnik. The results of factory production control shall be recorded and evaluated in accordance with the provisions of the control plan.

3.2.1.2 Other tasks for the manufacturer

The manufacturer shall, on the basis of a contract, involve a body which is approved for the tasks referred to in section 3.1 in the field of anchors in order to undertake the actions laid down in section 3.2.2 For this purpose, the control plan referred to in sections 3.2.1.1 and 3.2.2 shall be handed over by the manufacturer to the approved body involved.

The manufacturer shall make a declaration of conformity, stating that the construction product is in conformity with the provisions of this European technical approval.

3.2.2 Tasks for the approved bodies

The approved body shall perform the

- initial type-testing of the product,
- initial inspection of factory and of factory production control,
- continuous surveillance, assessment and approval of factory production control,

in accordance with the provisions laid down in the control plan.

The approved body shall retain the essential points of its actions referred to above and state the results obtained and conclusions drawn in a written report.

The approved certification body involved by the manufacturer shall issue an EC certificate of conformity of the product stating the conformity with the provisions of this European technical approval.

In cases where the provisions of the European technical approval and its control plan are no longer fulfilled the certification body shall withdraw the certificate of conformity and inform Deutsches Institut für Bautechnik without delay.

3.3 CE marking

The CE marking shall be affixed on each packaging of the anchor. The letters "CE" shall be followed by the identification number of the approved certification body, where relevant, and be accompanied by the following additional information:

- the name and address of the producer (legal entity responsible for the manufacture),
- the last two digits of the year in which the CE marking was affixed,
- the number of the EC certificate of conformity for the product,
- the number of the European technical approval,
- ETAG 029,
- use category (b, c, and d/d, w/d) and
- size.

⁹ The control plan is a confidential part of the European technical approval and only handed over to the approved body involved in the procedure of attestation of conformity. See section 3.2.2.

4 Assumptions under which the fitness of the product for the intended use was favourably assessed

4.1 Manufacturing

The European technical approval is issued for the product on the basis of agreed data/information, deposited with Deutsches Institut für Bautechnik, which identifies the product that has been assessed and judged. Changes to the product or production process, which could result in this deposited data/information being incorrect, should be notified to Deutsches Institut für Bautechnik before the changes are introduced.

Deutsches Institut für Bautechnik will decide whether or not such changes affect the approval and consequently the validity of the CE marking on the basis of the approval and if so whether further assessment or alterations to the approval shall be necessary.

4.2 Design of anchorages

The fitness of the anchor for the intended use is given under the following conditions:

The anchorages are designed in accordance with the ETAG 029, Annex C¹⁰, Design method A under the responsibility of an engineer experienced in anchorages and masonry work.

The length of the fastening screws or anchor rods for the anchor with internal threaded sockets shall be determined depending on the thickness of the fixture, the required minimum thread engagement length and the admissible tolerances.

Verifiable calculation notes and drawings are prepared taking account the relevant masonry in the region of the anchorage (nature and strength of the base materials), the loads to be transmitted and their transmission to the supports of the structure. The position of the anchor is indicated on the design drawings (e.g. position of the anchor relative to supports etc.).

The characteristic resistances are only valid for kind of bricks according to Annexes 7 and 8. The characteristic resistance for use in solid masonry are also valid for larger brick sizes and larger compressive strength of the masonry unit.

For other bricks in solid masonry and in hollow or perforated masonry, the characteristic resistance of the anchor may be determined by job site tests according to ETAG, Annex B¹¹ under consideration of the β -factor according to Annex 9, Table 10.

4.3 Installation

The fitness for use of the anchor can only be assumed if the anchor is installed as follows:

- anchor installation carried out by appropriately qualified personnel and under the supervision of the person responsible for technical matters of the site,
- use of the anchor only as supplied by the manufacturer without exchanging the components of an anchor,
- anchor installation in accordance with the manufacturer's specifications and drawings using the tools indicated in the technical documentation of this European technical approval,

¹⁰ The Guideline ETAG 029, "Metal Injection Anchors for Use in Masonry, Annex C: Design Methods for Anchorages" is published in English on EOTA website www.eota.eu.

¹¹ The Guideline ETAG 029, "Metal Injection Anchors for Use in Masonry, Annex B: Recommendations for tests to be carried out on construction works" is published in English on EOTA website www.eota.eu.

- commercial standard threaded rods, washers and hexagon nuts may also be used if the following requirements are fulfilled:
 - material, dimensions and mechanical properties of the metal parts according to the specifications given in Annex 3, Table 2,
 - confirmation of material and mechanical properties of the metal parts by inspection certificate 3.1 according to EN 10204:2004, the documents should be stored,
 - marking of the threaded rod with the envisage embedment depth. This may be done by the manufacturer of the rod or the person on jobsite.
- checks before placing the anchor to ensure that the use category applies and that the characteristic values of the base material in which the anchor is to be placed, is identical with the values, which the characteristic loads apply for.
- holes to be drilled perpendicular to the surface of the base material by percussion drilling,
- in case of aborted drill hole the drill hole shall be filled with mortar,
- hole cleaning and anchor installation in accordance with manufacturer's installation instructions (Annex 6),
- keeping the installation parameters (Annex 5),
- marking and keeping the effective anchorage depth,
- keeping edge distance and spacing according to Annex 5 without minus tolerances,
- observing the curing time according to Annex 4, Table 3 until the anchor may be loaded,
- fastening screws or anchor rods for the internal threaded sockets must be made of galvanized steel of the strength class 5.8; nuts and washers shall correspond to the specification in Annex 3, Table 2.

5 Indications to the manufacturer

5.1 Manufacturer's responsibilities

It is in the responsibility of the manufacturer to ensure that the information on the specific conditions according to 1 and 2 to as well as sections 4.2, 4.3 and 5.2 is given to those who are concerned. This information may be made by reproduction of the respective parts of the European technical approval. In addition all installation data shall be shown clearly on the package and/or on an enclosed instruction sheet, preferably using illustration(s).

The minimum data required are:

- installation parameters according to Annex 5,
- material and property class of metal parts according to Annex 3, Table 2,
- information on the installation procedure, including cleaning of the hole with the cleaning equipments, preferably by means of an illustration,
- exact volume of injection mortar depend on the relevant installation,
- storage temperature of anchor components, minimum and maximum temperature of the base material, processing time (open time) of the mortar and curing time until the anchor may be loaded according to Annex 4,
- identification of the manufacturing batch.

All data shall be presented in a clear and explicit form.

European technical approval

ETA-12/0306

English translation prepared by DIBt

Page 8 of 17 | 23 August 2012

5.2 Recommendations regarding packaging, transport and storage

The injection cartridges shall be protected against sun radiation and shall be stored according to the manufacturer's installation instructions in dry condition at temperatures of at least +5 °C to not more than +25 °C.

Mortar cartridges with expired shelf life must no longer be used.

Georg Feistel
Head of Department

beglaubigt:
Wittstock

Installation in hollow or perforated brick masonry

Installation of anchor rod with sieve sleeve

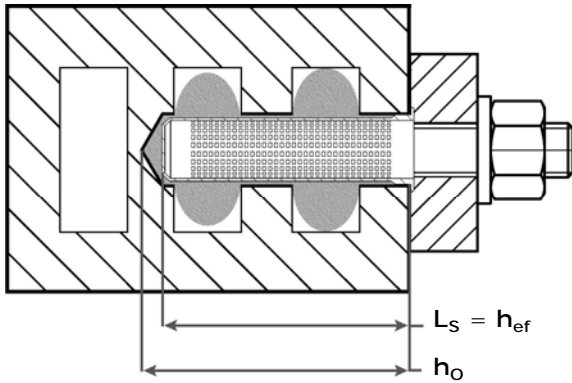

Installation of internal threaded socket with sieve sleeve

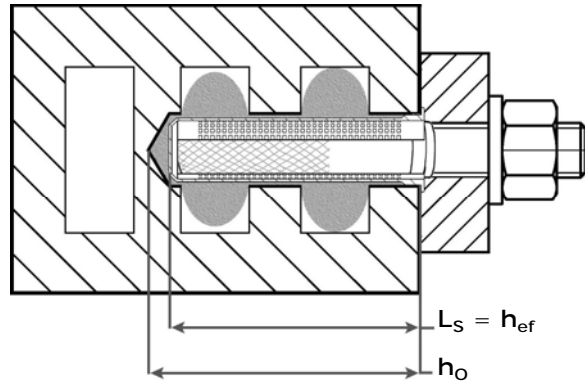

Installation in solid brick masonry

Installation of anchor rod with or without sieve sleeve

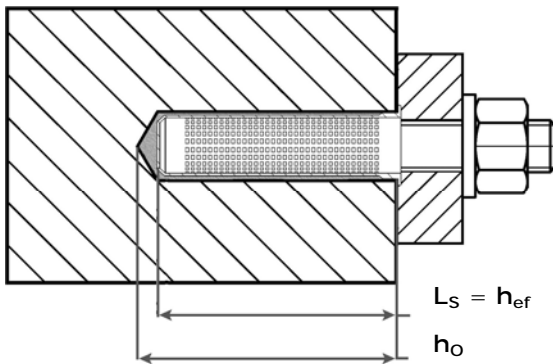

Installation of internal threaded socket with sieve sleeve

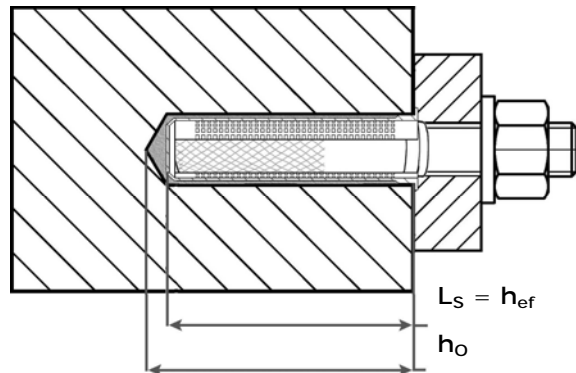

L_S = length of the sieve sleeve
 h_{ef} = effective anchorage depth
 h_o = depth of drill hole

Use categories

Base material: use category b and c (solid, hollow or perforated masonry)
 Installation and use: category d/d (installation in dry masonry, use in structures subject to dry, internal conditions)
 category w/d (installation in wet masonry, use in structures subject to dry, internal conditions)
 Temperature range: -40 °C to +80 °C (maximum long term temperature +50 °C, maximum short term temperature +80 °C)

INDEX Injection System MOPOSE

Product and intended use

Annex 1

Anchor rod M8, M10, M12 with washer and hexagon nut

h_{ef} = marking of the anchorage depth

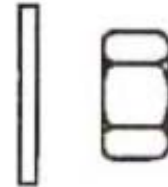
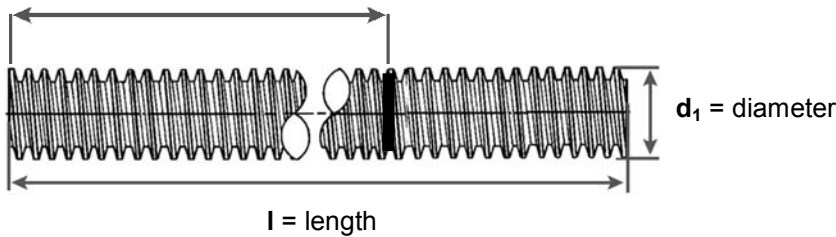

Internal threaded socket

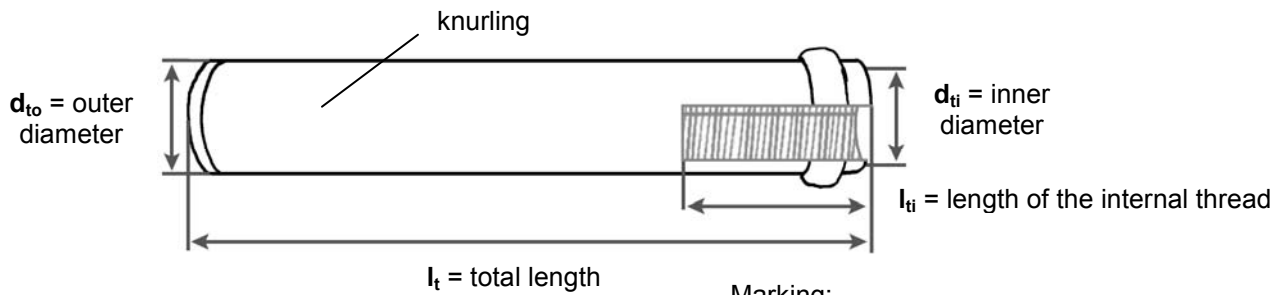

Marking:
Identifying mark of the producer "m",
Size of internal thread e.g. M8

Table 1: Dimensions of internal threaded sockets (in mm)

Internal threaded socket	d_{ti}	d_{to}	l_{ti}	l_t
12 x 80	M8	12	30	80
14 x 80	M10	14	30	80
16 x 80	M12	16	30	80

Sieve sleeve

Types
SH15/85,
SH16/85,
SH20/85

d_s = diameter
(15 mm, 16 mm,
20 mm)

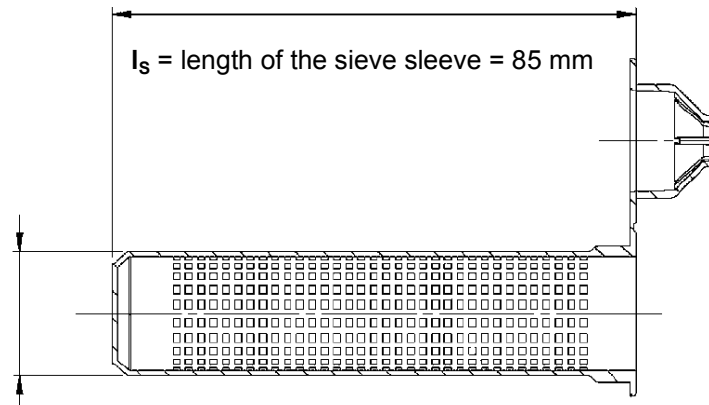

INDEX Injection System MOPOSE

Components of the anchor

Annex 2

Table 2: Materials

Designation	Material
Anchor rod	Steel, strength class 5.8 EN ISO 898-1, galvanized $\geq 5 \mu\text{m}$ EN ISO 4042
Washer	Steel, galvanized $\geq 5 \mu\text{m}$ EN ISO 4042
Hexagon nut	strength class 5 EN 20898-2, galvanized $\geq 5 \mu\text{m}$ EN ISO 4042
Internal threaded socket	strength class 5.8 EN ISO 898-1, galvanized $\geq 5 \mu\text{m}$ EN ISO 4042
Sieve sleeve	Polypropylene
Chemical mortar	Styrene free polyester resin, hardener, additive

Mortar cartridges

Imprint: INDEX, Injection System MOPOSE, processing notes, shelf life, hazard-code, curing time and processing time

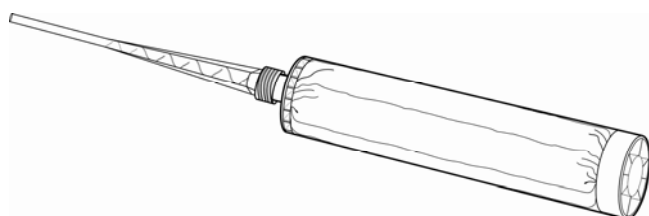

Two part foil capsule within a single component cartridge
FCC 150 MOPOSE
FCC 170 MOPOSE
FCC 300 MOPOSE

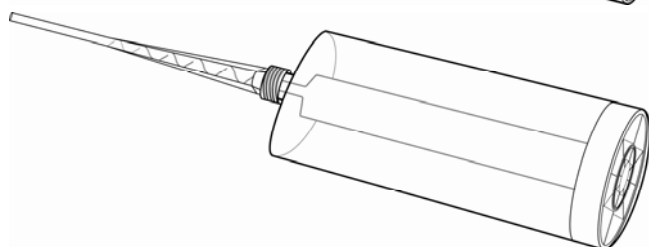

Coaxial Cartridge
CC 150 MOPOSE
CC 330 MOPOSE
CC 380 MOPOSE
CC 410 MOPOSE

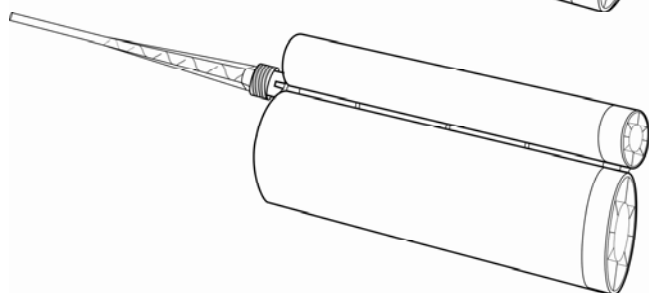

Side-by-Side Cartridge
SBS 345 MOPOSE
SBS 825 MOPOSE

Mixing nozzles

Replace when work is interrupted

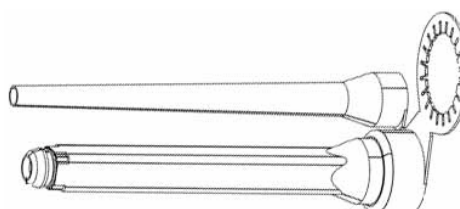

INDEX Injection System MOPOSE

Materials, mortar cartridges, mixing nozzles

Annex 3

Table 3: Curing time and processing time

Temperature in masonry	Minimum Curing time	Maximum Processing time
$5^{\circ}\text{C} \leq T < 10^{\circ}\text{C}$	145 minutes	18 minutes
$10^{\circ}\text{C} \leq T < 20^{\circ}\text{C}$	85 minutes	10 minutes
$20^{\circ}\text{C} \leq T < 25^{\circ}\text{C}$	50 minutes	6 minutes
$25^{\circ}\text{C} \leq T < 30^{\circ}\text{C}$	40 minutes	5 minutes
30°C	35 minutes	4 minutes

Cleaning brush

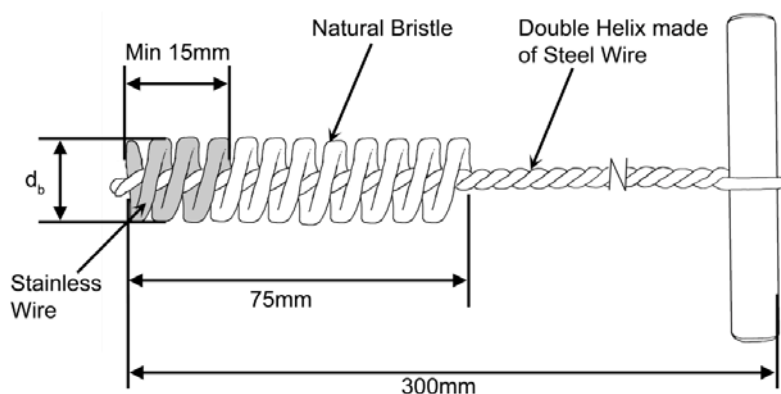

Double bristle brush diameter d_b according to Table 4

Cleaning pump

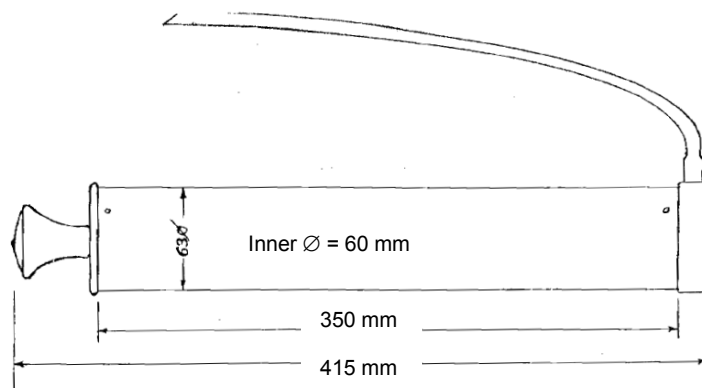

Index cleaning pump

INDEX Injection System MOPOSE

Curing times, cleaning equipment

Annex 4

Table 4: Installation parameters

Anchor type		Anchor rod						Internal threaded socket					
Size		M8	M10	M12	M8	M10	M12	M8	M10	M12			
Internal threaded socket	$d_{to} \times l_t$ [mm]	-	-	-	-	-	-	12x80	14x80	16x80			
	l_s [mm]	-	-	-	85	85	85	85	85	85			
Sieve sleeve	d_s [mm]	-	-	-	15	16	15	16	20	15	16	20	20
	d_o [mm]	15	15	20	15	16	15	16	20	15	16	20	20
Diameter of cleaning brush	d_b [mm]	20 \pm 1	20 \pm 1	22 \pm 1	20 \pm 1	20 \pm 1	22 \pm 1	20 \pm 1	22 \pm 1	22 \pm 1			
Depth of the drill hole	h_o [mm]	90											
Effective anchorage depth	h_{ef} [mm]	85						80					
Diameter of clearance hole in the fixture	$d_f \leq$ [mm]	9	12	14	9	12	14	9	12	14			
Torque moment	$T_{inst} \leq$ [Nm]	2											

Table 5: Edge distances and spacings

Base material ¹⁾	Anchor rods						Internal threaded sockets					
	M8		M10		M12		M8		M10		M12	
	s_{min} c_{min} [mm]	s_{cr} [mm]	s_{min} c_{min} [mm]	s_{cr} [mm]	s_{min} c_{min} [mm]	s_{cr} [mm]	s_{min} c_{min} [mm]	s_{cr} [mm]	s_{min} c_{min} [mm]	s_{cr} [mm]	s_{min} c_{min} [mm]	s_{cr} [mm]
Brick N° 1	100	235	100	235	120	235	100	235	120	235	120	235
Brick N° 2	100	250	100	250	120	250	-	-	120	250	120	250
Brick N° 3	50	160	50	200	60	240	50	240	60	280	60	320
Brick N° 4	50	160	50	200	60	240	50	240	60	280	60	320
Brick N° 5	100	250	100	250	120	250	100	250	120	250	120	250
Brick N° 6	100	250	100	250	-	-	100	250	120	250	120	250
Brick N° 7	100	250	100	250	120	250	-	-	120	250	120	250
Brick N° 8	100	370	100	370	120	370	100	370	120	370	120	370







¹⁾ Brick N° according to Annex 7 and 8

INDEX Injection System MOPOSE

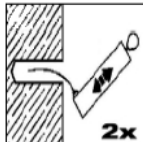
Installation parameters, Edge distances and spacings

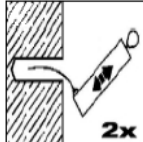
Annex 5

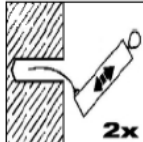
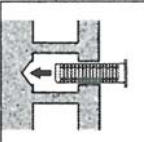
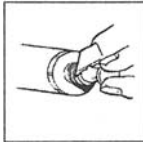
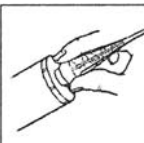
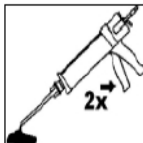
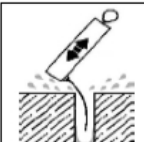
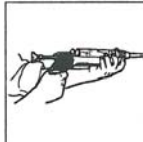
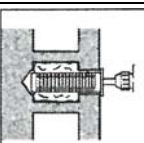
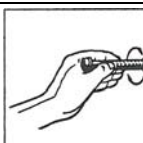
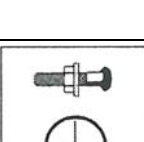
Installation instructions

	1. Drill the hole to the correct diameter and depth using a rotary percussive machine.		2. Use the Index cleaning pump to clean the hole.
	3. Use the Index cleaning brush to clean the hole. Diameter of cleaning brush according to Table 4.		4. Use the Index cleaning pump to clean the hole.
	5. Use the Index cleaning brush to clean the hole. Diameter of cleaning brush according to Table 4.		6. Use the Index cleaning pump to clean the hole.
	7. If use in hollow or perforated brick masonry: Plug the centering cap and insert the correct perforated sleeve flush with the surface of the base material.		8. Once the hole is prepared remove the screw cap from the cartridge.
	9. Attach the mixer nozzle and place the cartridge in the applicator gun.		10. Dispense the first part to waste, until an even colour is achieved.
	11. Remove any free water from the hole.		12. Insert the nozzle to the far end of the hole (using extension tubing if necessary) and inject the resin, withdrawing the nozzle/tube as the hole fills.
	13. If use in hollow or perforated brick masonry: Insert mixer nozzle to the end of the perforated sleeve and completely fill the sleeve with resin. Withdraw the mixer nozzle as the sleeve fills.		14. Immediately insert the fixing (steel element) slowly and with a slight twisting motion. Remove excess resin from around the mouth of the hole.
	15. Leave the fixing undisturbed until the cure time (see Table 3) has elapsed.		16. Attach the fixture and tighten the nut. Maximum installation torque moment according to Table 4.

INDEX Injection System MOPOSE

Installation instructions

Annex 6

Table 6.1: Types and dimensions of blocks and bricks

Brick N° 1

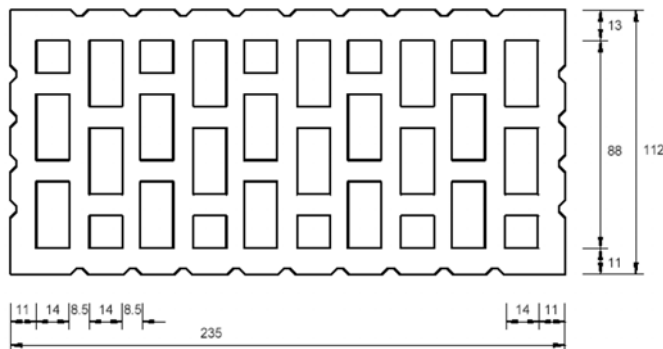

Hollow clay brick HLz 12-1,0-2DF
according to EN 771-1
length/width/height = 235 mm/112 mm/115 mm
 $f_b \geq 12 \text{ N/mm}^2 / \rho \geq 1,0 \text{ kg/dm}^3$

Brick N° 2a

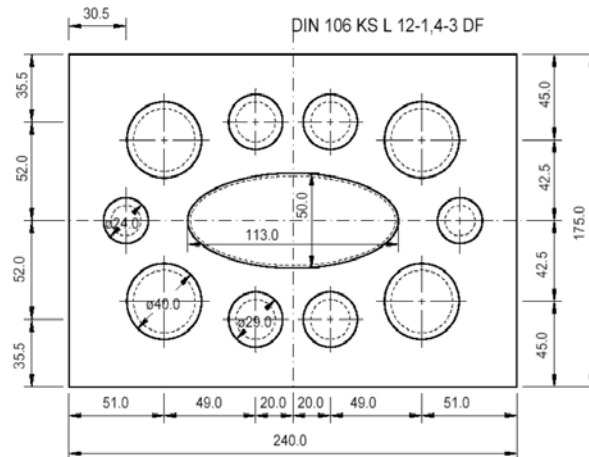

Hollow sand lime brick KSL 12-1,4-3DF
according to EN 771-2
length/width/height = 240 mm/175 mm/113 mm
 $f_b \geq 12 \text{ N/mm}^2 / \rho \geq 1,4 \text{ kg/dm}^3$

Brick N° 2b

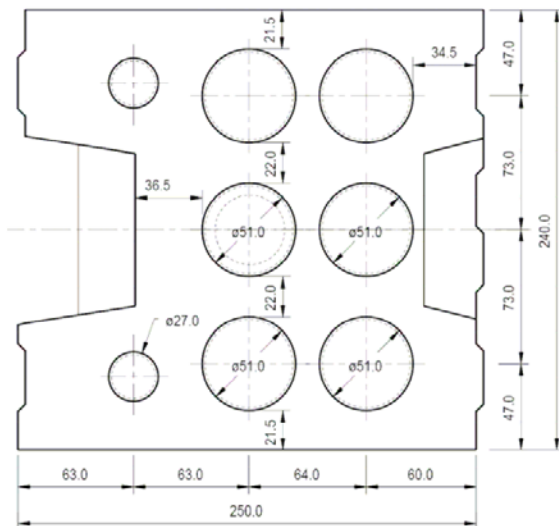

Hollow sand lime brick KSL 12-1,4-8DF
according to EN 771-2
length/width/height = 250 mm/240 mm/237 mm
 $f_b \geq 12 \text{ N/mm}^2 / \rho \geq 1,4 \text{ kg/dm}^3$

Brick N° 3

Solid clay brick Mz 12-2,0-NF
according to EN 771-1
length/width/height = 240 mm/116 mm/71 mm
 $f_b \geq 12 \text{ N/mm}^2 / \rho \geq 2,0 \text{ kg/dm}^3$

Brick N° 4

Solid sand lime brick KS 12-2,0-NF
according to EN 771-2
length/width/height = 240 mm/115 mm/70 mm
 $f_b \geq 12 \text{ N/mm}^2 / \rho \geq 2,0 \text{ kg/dm}^3$

INDEX Injection System MOPOSE

Types and dimensions of blocks and bricks (part 1)

Annex 7

Table 6.2: Types and dimensions of blocks and bricks

<p>Brick N° 5</p> <p>Hollow clay brick HLzW 6-0,7-8DF according to EN 771-1 length/width/height = 250 mm/240 mm/240 mm $f_b \geq 6 \text{ N/mm}^2 / \rho \geq 0,8 \text{ kg/dm}^3$</p>	<p>Brick N° 6</p> <p>Lightweight concrete hollow block Hbl 2-0,45-10DF according to EN 771-3 length/width/height = 250 mm/300 mm/248 mm $f_b \geq 2,0 \text{ N/mm}^2 / \rho \geq 0,45 \text{ kg/dm}^3$</p>
<p>Brick N° 7</p> <p>Lightweight concrete hollow block Hbl 4-0,7-8DF according to EN 771-3 length/width/height = 250 mm/240 mm/248 mm $f_b \geq 4,0 \text{ N/mm}^2 / \rho \geq 0,7 \text{ kg/dm}^3$</p>	<p>Brick N° 8</p> <p>Concrete masonry unit Hbn 4-12DF according to EN 771-3 length/width/height = 370 mm/240 mm/238 mm $f_b \geq 4 \text{ N/mm}^2 / \rho \geq 1,2 \text{ kg/dm}^3$</p>

INDEX Injection System MOPOSE

Types and dimensions of blocks and bricks (part 2)

Annex 8

Table 7: Characteristic resistance under tension and shear loading

Base material	Anchor rods $N_{Rk} = V_{Rk}$ [kN] ¹⁾			Internal threaded sockets $N_{Rk} = V_{Rk}$ [kN] ¹⁾		
	M8	M10	M12	M8	M10	M12
Brick N° 1	2,5	2,0	2,0	1,5	2,5	2,5
Brick N° 2	0,75	1,2	0,5	-	0,75	0,4
Brick N° 3	1,5	1,5	3,0	2,0	3,0	4,0
Brick N° 4	0,75	0,9	1,5	2,0	1,5	0,9
Brick N° 5	1,2	1,2	0,9	0,9	1,5	0,6
Brick N° 6	0,6	0,3	-	0,5	0,3	0,75
Brick N° 7	0,6	1,5	1,2	-	0,4	0,6
Brick N° 8	2,5	1,5	2,5	0,6	1,2	0,9
Partial safety factor γ_M	2,5 ²⁾			2,5 ²⁾		

¹⁾ for design according to ETAG 029, Annex C:

for all masonry units:

$$N_{Rk} = N_{Rk,p} = N_{Rk,b} = N_{Rk,pb} = N_{Rk,s}$$

for perforated or hollow masonry units: $V_{Rk} = V_{Rk,b} = V_{Rk,c} = V_{Rk,s}$

for solid masonry units:

$$V_{Rk} = V_{Rk,b} = V_{Rk,s} \text{ and}$$

$V_{Rk,c}$ have to be calculated according to ETAG 029, Annex C

²⁾ in absence of other national regulations

Table 8: Characteristic bending moments

Anchor rod	M8	M10	M12
Characteristic bending moment $M_{Rk,s}$ [Nm] (steel, strength class 5.8)	19	37	65
Partial safety factor γ_{Msv}	1,25 ¹⁾		

¹⁾ in absence of other national regulations

Table 9: Displacements under tension and shear load

Base material	F [kN]	δ_{N0} [mm]	$\delta_{N\infty}$ [mm]	δ_{V0} [mm]	$\delta_{V\infty}$ [mm]
Solid bricks	$N_{Rk} / (1,4 \cdot \gamma_M)$	0,6	1,2	1,0 ¹⁾	1,5 ¹⁾
Perforated and hollow bricks		0,14	0,28	1,0 ¹⁾	1,5 ¹⁾

¹⁾ the hole gap between bolt and fixture shall be considered additionally

Table 10: β - factors for job site tests according to ETAG 029, Annex B

Brick N°	N° 1	N° 2	N° 3	N° 4	N° 5	N° 6	N° 7	N° 8
β - factor	0,62	0,22	0,48	0,26	0,43	0,42	0,36	0,60

INDEX Injection System MOPOSE

Characteristic resistance, displacements, β – factors for job site tests

Annex 9