

European Technical Approval ETA-10/0295

English translation prepared by DIBt - Original version in German language

Handelsbezeichnung <i>Trade name</i>	"Wolfin IB"
Zulassungsinhaber <i>Holder of approval</i>	Wolfin Bautechnik GmbH Am Rosengarten 5 63607 Wächtersbach-Neudorf DEUTSCHLAND
Zulassungsgegenstand und Verwendungszweck <i>Generic type and use of construction product</i>	Dichtungsbahn "Wolfin IB" als Abdichtungsmittel von Auffangwannen und -räumen in Anlagen zum Lagern wassergefährdender Stoffe <i>Plastic sheets 'Wolfin IB' for the lining of collecting basins and rooms for the storage of liquids hazardous to water</i>
Geltungsdauer: <i>Validity:</i>	vom <i>from</i> bis <i>to</i> 17 June 2013 26 August 2015
Herstellwerk <i>Manufacturing plant</i>	Werk 001

Diese Zulassung umfasst
This Approval contains

28 Seiten einschließlich 18 Anhänge
28 pages including 18 annexes

Diese Zulassung ersetzt
This Approval replaces

ETA-10/0295 mit Geltungsdauer vom 26.08.2010 bis 26.08.2015
ETA-10/0295 with validity from 26.08.2010 to 26.08.2015

I LEGAL BASES AND GENERAL CONDITIONS

- 1 This European technical approval is issued by Deutsches Institut für Bautechnik in accordance with:
 - Council Directive 89/106/EEC of 21 December 1988 on the approximation of laws, regulations and administrative provisions of Member States relating to construction products¹, modified by Council Directive 93/68/EEC² and Regulation (EC) N° 1882/2003 of the European Parliament and of the Council³;
 - *Gesetz über das In-Verkehr-Bringen von und den freien Warenverkehr mit Bauprodukten zur Umsetzung der Richtlinie 89/106/EWG des Rates vom 21. Dezember 1988 zur Angleichung der Rechts- und Verwaltungsvorschriften der Mitgliedstaaten über Bauprodukte und anderer Rechtsakte der Europäischen Gemeinschaften (Bauproduktengesetz - BauPG) vom 28. April 1998⁴, as amended by Article 2 of the law of 8 November 2011⁵;*
 - Common Procedural Rules for Requesting, Preparing and the Granting of European technical approvals set out in the Annex to Commission Decision 94/23/EC⁶.
- 2 Deutsches Institut für Bautechnik is authorized to check whether the provisions of this European technical approval are met. Checking may take place in the manufacturing plant. Nevertheless, the responsibility for the conformity of the products to the European technical approval and for their fitness for the intended use remains with the holder of the European technical approval.
- 3 This European technical approval is not to be transferred to manufacturers or agents of manufacturers other than those indicated on page 1, or manufacturing plants other than those indicated on page 1 of this European technical approval.
- 4 This European technical approval may be withdrawn by Deutsches Institut für Bautechnik, in particular pursuant to information by the Commission according to Article 5(1) of Council Directive 89/106/EEC.
- 5 Reproduction of this European technical approval including transmission by electronic means shall be in full. However, partial reproduction can be made with the written consent of Deutsches Institut für Bautechnik. In this case partial reproduction has to be designated as such. Texts and drawings of advertising brochures shall not contradict or misuse the European technical approval.
- 6 The European technical approval is issued by the approval body in its official language. This version corresponds fully to the version circulated within EOTA. Translations into other languages have to be designated as such.

¹ Official Journal of the European Communities L 40, 11 February 1989, p. 12
² Official Journal of the European Communities L 220, 30 August 1993, p. 1
³ Official Journal of the European Union L 284, 31 October 2003, p. 25
⁴ *Bundesgesetzblatt Teil I 1998*, p. 812
⁵ *Bundesgesetzblatt Teil I 2011*, p. 2178
⁶ Official Journal of the European Communities L 17, 20 January 1994, p. 34

II SPECIFIC CONDITIONS OF THE EUROPEAN TECHNICAL APPROVAL

1 Definition of product and intended use

1.1 Definition of the construction product

(1) The plastic sheets "Wolfin IB" are made of plasticized polyvinyl chloride.

(2) The plastic sheets are made with plain surface on both sides with a nominal thickness of 1.5 mm and 2.0 mm. The plastic sheets are laid loosely on the prepared ground and joined by welding to a lining of collecting rooms passable by pedestrians.

1.2 Intended use

(1) The plastic sheets are intended for use as a lining of collecting basins and collecting rooms inside as well as outside of buildings for the storage of liquids according to Annex 1.

(2) During the storage of extremely flammable, highly flammable and flammable liquids according to the European Commission directive 67/548/EWG plastic sheets shall only be used if the regulations to prevent risks by electrostatic charges are met (s. CLC/TR 50404⁷).

(3) The plastic sheets may be installed at normal environmental, structural element and material temperatures (usually within a range of +5 °C to + 40 °C) and used at temperatures between - 20 °C and + 70 °C.

(4) The provisions made in this European technical approval are based on an assumed working life of the plastic sheets of 10 years (if the sheets are installed at outdoor exposure) respectively 25 years (if the sheets are covered or installed in buildings), provided that the conditions laid down in sections 4.2, 5.1 and 5.2 for the installation, packaging, transport, storage, use, maintenance and repair are met. The indications given on the working life cannot be interpreted as a guarantee given by the producer, but are to be regarded only as a means for choosing the right products in relation to the expected economically reasonable working life of the works.

2 Characteristics of product and methods of verification

2.1 Essential requirement N° 2: Safety in case of fire

The plastic sheets meet the requirements of the Class E according to EN 13501-1⁸.

2.2 Essential requirement N° 3: Hygiene, health and environment

2.2.1 Composition

(1) The chemical composition respectively formulation of the plastic sheets and the description of the production process are confidential and deposited with Deutsches Institut für Bautechnik in the technical documentation⁹ to this European technical approval.

⁷ CLC/TR 50404:2003 Electrostatics – Code of practice for the avoidance of hazards due to static electricity

⁸ EN 13501-1:2007-02 Fire classification of construction products and building elements – Part 1: Classification using data from reaction to fire tests:

⁹ The technical documentation of this European technical approval is deposited with Deutsches Institut für Bautechnik and shall be made available to the approved bodies, who are involved in the procedure of conformity attestation, for the fulfilment of their tasks.

(2) The product characteristics of the plastic sheets including the appropriate verification methods are given in Annex 2.

2.2.2 Release of dangerous substances

(1) According to the manufacturer's declaration the plastic sheets taking account of the EU database¹⁰ do not contain any dangerous substances.

(2) In addition to the specific clauses of this European technical approval relating to dangerous substances contained in this European technical approval, there may be other requirements applicable to the products falling within its scope (e.g. transposed European legislation and national laws, regulations and administrative provisions). In order to meet the provisions of the Construction Products Directive, these requirements need also to be complied with, when and where they apply.

2.2.3 Properties

(1) The plastics sheets are impermeable and resistant to the liquids given in Annex 1 for the load levels "high" (class S3) respectively "medium" (class S2) (definition of the load levels see Annex 1).

(2) The plastic sheets

- are resistant against aging and weather influence,
- are resistant against micro-organisms,
- are passable by pedestrians for maintenance purposes and
- meet for the combined mechanical and thermal fixing to the wall according to Annex 12 the requirement of the class "sb1" for the slipping behaviour.

3 Evaluation and attestation of conformity and CE marking

3.1 System of attestation of conformity

According to the communication of the European Commission¹¹ system 2+ of the attestation of conformity applies. In addition, according to the communication of the European Commission¹¹ system 3 of the attestation of conformity applies with regard to reaction to fire.

These systems of attestation of conformity are defined in the following:

System 2+: Declaration of conformity of the product by the manufacturer on the basis of:

- (a) Tasks for the manufacturer:
- (1) initial type-testing of the product;
 - (2) factory production control;
 - (3) testing of samples taken at the factory in accordance with a prescribed test plan.
- (b) Tasks for the approved body:
- (4) certification of factory production control on the basis of:
 - initial inspection of factory and of factory production control;
 - continuous surveillance, assessment and approval of factory production control.

¹⁰ References in Guidance Paper H: A harmonised approach with regard to the handling of dangerous substances according to the Construction Products Directive, Brussels 18 February 2000.

¹¹ Letter of the European Commission of 01/08/2005 to EOTA.

System 3: Declaration of conformity of the product by the manufacturer on the basis of:

- (a) Tasks for the manufacturer:
 - (1) factory production control;
- (b) Tasks for the approved body:
 - (2) initial type-testing of the product.

Note: Approved bodies are also referred to as "notified bodies".

3.2 Responsibilities

3.2.1 Tasks for the manufacturer

3.2.1.1 Factory production control

(1) The manufacturer shall exercise permanent internal control of production. All the elements, requirements and provisions adopted by the manufacturer shall be documented in a systematic manner in the form of written policies and procedures, including records of results performed. This production control system shall insure that the product is in conformity with this European technical approval.

(2) The manufacturer may only use initial, raw and constituent materials stated in the technical documentation of this European technical approval.

(3) The factory production control shall be in accordance with the "Control plan of 17 August 2010 relating to the European technical approval ETA-10/0295 issued on 26 August 2010" which is part of the technical documentation of this European technical approval. The control plan is laid down in the context of the factory production control system operated by the manufacturer and deposited with Deutsches Institut für Bautechnik.¹²

(4) The results of factory production control shall be recorded and evaluated in accordance with the provisions of the control plan.

3.2.1.2 Other tasks for the manufacturer

(1) The manufacturer shall, on the basis of a contract, involve bodies which are approved for the tasks referred to in section 3.1 in the field of plastic sheets for the lining of collecting basins and collecting rooms for the storage of liquids hazardous to water in order to undertake the actions laid down in section 3.2.2. For this purpose, the control plan referred to in sections 3.2.1.1 and 3.2.2 shall be handed over by the manufacturer to the approved bodies involved.

(2) The manufacturer shall make a declaration of conformity, stating that the construction product is in conformity with the provisions of the European technical approval ETA-10/0295 issued on 17 June 2013.

3.2.2 Tasks for the approved bodies

3.2.2.1 Initial type-testing of the product with regard to reaction to fire

- (1) The approved body shall perform the
 - initial type-testing of the product

in accordance with the provisions laid down in the control plan.

(2) The approved body shall retain the essential points of its actions referred to above and state the results obtained and conclusions drawn in a written report.

¹²

The control plan is a confidential part of the European technical approval and only handed over to the approved bodies involved in the procedure of attestation of conformity. See section 3.2.2.

3.2.2.2 Initial inspection of factory and continuous surveillance

(1) The approved body shall perform the

- initial inspection of factory and of factory production control and
- continuous surveillance, assessment and approval of factory production control in accordance with the provisions laid down in the control plan.

(2) The approved body shall retain the essential points of its actions referred to above and state the results obtained and conclusions drawn in a written report.

(3) The approved certification body involved by the manufacturer shall issue an EC certificate of conformity of the factory production control stating the conformity with the provisions of this European technical approval.

(4) In cases where the provisions of the European technical approval and its control plan are no longer fulfilled the certification body shall withdraw the certificate of conformity and inform Deutsches Institut für Bautechnik without delay.

3.3 CE marking

The CE marking shall be affixed on the delivery. The letters „CE“ shall be followed by the identification number of the approved certification body, where relevant, and be accompanied by the following additional information:

- the name and address of the producer (legal entity responsible for the manufacture),
- the last two digits of the year in which the CE marking was affixed,
- the number of the EC certificate for the factory production control,
- the number of the European technical approval,
- essential properties:
 - reaction-to-fire class,
 - use inside/outside of buildings,
 - resistance to media shall be given with the number of the media group and the classes of the load levels and
 - class of slipping behaviour in case of fire for the combined mechanical and thermal fixing to the wall.

4 Assumptions under which the fitness of the product for the intended use was favourably assessed

4.1 Manufacturing

(1) The plastic sheets are produced in plant no. 001 accordance with the production process, which is stated in the technical documentation to this European technical approval.

(2) The European technical approval is issued for the plastic sheet on the basis of agreed data and information (formulation and production process), deposited with Deutsches Institut für Bautechnik, which identifies the product that has been assessed and judged.

(3) Changes to the product or production process, which could result in this deposited data and information being incorrect, should be notified to Deutsches Institut für Bautechnik before the changes are introduced. Deutsches Institut für Bautechnik will decide whether or not such changes affect the approval and consequently the validity of the CE marking on the basis of the approval and if so whether further assessment or alterations to the approval shall be necessary.

4.2 Installation

4.2.1 Conditions for the installation in concrete and masonry works

The design takes the following into account:

- The substrate for the plastic sheets is to be manufactured based on EN 14879-1¹³ and shall already have the specified bottom slope. Edges and channels shall be carried out sharp-edged.
- Penetration of ground moisture, ground and seepage or other water from the back side into the works has to be avoided. If ground moisture, ground and seepage or other water occur, the works have to be sealed in accordance with the national provisions of the Member States.
- During the installation of the plastic sheets the nature of the concrete substrate has to satisfy the requirements of EN 14879-1¹³, section 4.2.2. These may be achieved by a treatment of the concrete substrate according to sections 4.2.2.3.2 and 4.2.2.4 of this standard. Furthermore the installation of separating layer and/or levelling course such as screed and/or geotextile with a mass per unit area of at least 400 g/m² is also possible. Masonry as a substrate is suited for plastic sheets, if it satisfy the requirements of EN 14879-1¹³, section 4.2.1.9.
- In case of collecting basins and collecting rooms to be repaired, the requirements of EN 14879-1¹³, section 4.2.1.9 shall be met accordingly.
- Deviating from the provisions mentioned above, in case of collecting basins and collecting rooms to be redeveloped, the crack widths up to 1.5 mm are permissible instead of crack widths according to EN 14879-1¹³, section 4.2.1.2. Larger cracks shall be back-filled appropriately.
- Prior to the installation stability of collecting basins and collecting rooms has to be proved.

4.2.2 Conditions for the installation in ground constructions

- The deepest point of the works shall be at least 50 cm above the highest expected groundwater level. If accumulating seepage is expected, ground constructions can only be erected when drainage exists. Ground constructions may be erected only outside of the flood endangered areas.
- A rough grading which are free of stones, compressed and rolled off with a degree of compaction of 95 % of the simple proctor density is to be manufactured. Finally at least a concrete with compressive strengths of C20/25 (see EN 206-1¹⁴) according to the relevant static requirements with a component thickness of at least 15 cm shall be applied.
- Prior to the installation stability of collecting basins has to be proved.
- The substrate for the plastic sheets shall already have the specified bottom slope and perhaps the specified slope ratio.

4.2.3 Installation

(1) The installation of the plastic sheets is carried out by firms only who (including their specialists) are authorised and trained by the manufacturer. Further requirements for the installing firm can result from national provisions of the Member States.

¹³ EN 14879-1:2005-09 Organic coating systems and linings for protection of industrial apparatus and plants against corrosion caused by aggressive media – Part 1: Terminology, design and preparation of substrate

¹⁴ EN 206-1: 2001-07 Concrete – Part 1: Specification, performance, production and conformity

(2) The fitness of the installed plastic sheets can only be assumed, if the processing is in accordance with the conditions of this European technical approval and in accordance with the installation instruction of the manufacturer laid down in the technical documentation. The installation instruction shall address the following items:

- structural conditions as to substrate, for new and rebuilt constructions
- required work steps for the lining of collecting basins (e. g. lining of parts of areas)
- method of joining plastic sheets including preparation, conditioning and protection of joining areas
- test for joints
- re-working and repairing at the lining
- protecting the lining edges against separating from underground

(3) The plastic sheets are to be laid loose and unstressed with a cover of at least 8 cm (see Annex 4). The connections shall be such that no cruciform joint can occur and T-intersections are minimised. During the erection work on the plastic sheets it shall be made sure that damage of the plastic sheets is excluded. When laying outdoors, measures for storm protection of the laid sheets shall be taken.

(4) Welding of the plastic sheets occurs by means of the hot gas seam welding. The welding shall be carried out by personnel having a valid qualification testing according to EN 13067¹⁵ material group 6, sub-group 6.1 to 6.2 only, as well as the national provisions of the Member States. The joints are to be tested and recorded according to the national provisions of the Member States.

(5) The construction details shall correspond to Annexes 4 - 18.

(6) The confirmation of compatibility of the lining of collecting rooms installed at the mounting site with the provisions of this European technical approval as well as the installation instructions by the manufacturer contained in the technical documentation shall occur by the installing firm according to section 4.2.3 (1) with a manufacturing record (see Annex 3).

4.3 Responsibilities for the ETA holder

(1) It is the responsibility of the holder of approval to make sure that all those who use the plastic sheets will be appropriately informed about the specific conditions according to sections 1, 2, 4, and 5 including the annex to this ETA and the not confidential parts of the technical documentation to this ETA.

(2) The number of the ETA shall be given on the packaging (enclosed label) and on the plastic sheets (stamping or labelling at least each 5th running meter) readily identifiable and durably accompanied by the name of the ETA holder and the batch number.

(3) The manufacturer shall oblige the executing company to durably designate each collecting basin and/or each collecting room with the following information (supplied labels shall be used thereby):

For the lining of this collecting room

Plastic sheets:

Wolfin IB

Batch Number:

Number of approval:

ETA-10/0295

Holder of approval:

Wolfin Bautechnik GmbH

Am Rosengarten 5

D-63607 Wächtersbach-Neudorf

carried out on:

carried out by:

was used.

For repairing damage only materials indicated in the European technical approval in accordance with indications of the manufacturer shall be used!

5 Indications to the manufacturer

5.1 Packaging, transport and storage

Packaging, transport and storage of the plastic sheets shall be carried out so that the serviceability is not affected. The storage of the plastic sheets shall be foreseen on a flat substrate free of stones, taking into account that direct superimposing of the rolls is to be avoided. The plastic sheets shall be protected against direct solar radiation.

5.2 Use, maintenance, repair

(1) In order to ensure the fitness for use of the plastic sheets after installation in the works the measures described in sections (2) to (5) are recommended. It is the task of the ETA holder to make sure that all parties involved are adequately informed.

(2) Leaked out liquids hazardous to water are as fast as possible recognised and removed from the sealing surface at the latest after the load level according to Annex 1.

(3) Firms according to section 4.2.3 (1) only are charged with repair works; they may use only materials indicated in this European technical approval in accordance with the installation instruction being part of the technical documentation of the manufacturer.

(4) Damaged surfaces are covered with rounded cut-outs. The minimum overlapping on the edges shall be 10 cm. The cut-outs are made over the entire seams area according to technical rules by means of the hot gas welding. The continuous faulty seams and such with continuous irregularity shall be rejoined or covered along the length with sheet strip made of "Wolfin IB" of at least 0.6 m width, joined on both sides according to technical rules.

(5) If the whole area of the imperfection to be repaired exceeds 30 %, an expert person decides according to section 6 (4), whether repairing is still admissible. In case of more reworking, the recurring inspections according to section 6 (5) shall be repeated by an expert person.

6 Recommendations for the operator of a facility for the storage of liquids hazardous to water

(1) Reference is made to the necessity of a permanent surveillance by the operator of the facility in accordance with the requirements of the national regulations of the Member States.

(2) The operator of a facility for the storage of liquids hazardous to water commissions only firms with maintenance, repair and cleaning of the lining according to section 4.2.3 (1).

(3) The operator of a facility for the storage of liquids hazardous to water shall initiate inspections (commissioning inspection, recurring inspection) depending on national regulations by expert persons. The inspections shall be executed in accordance with section 6 (4) and section 6 (5).

(4) Prior to commissioning and following any significant modifications inspections are carried out only by expert persons. Further requirements for the expert personnel can result from national regulations of the Member States. The inspections shall be executed as follows:

- The inspection for fitting the tank and respectively prior to commissioning is carried out in the presence of an expert representative of the firm according to section 4.2.3 (1) and of the operator of the facility.
- The thickness of the plastic sheets to be laid should be tested randomly before installation. If a thickness arises which does not fulfil the requirements of Annex 2, the respective sheet shall be discarded and replaced by a new one corresponding to the requirements.
- An expert person checks the execution of the sealing according to plan for compatibility with the provisions of the European technical approval and the compliance with the official obligations and conditions. He examines the necessary verifications and the records relating to type, scope and result of the tests according to the construction of the works.
- If partial testing of single laid sections is not intended or was not possible, he checks the lining visually for obvious defects and damage, faultless execution of the joints, edges protection, covering as well as their connections on other parts of the works of the collecting rooms.

(5) Recurring inspections shall be executed as follows.

- The recurring inspections are carried out only by expert personnel. Further requirements for the expert personnel can result from national regulations of the Member State.
- The lining is spot-checked visually of their condition. The details of dashes 3 and 4 in section 6 (4) shall apply accordingly.
- If damage of lining will be observed during the recurring inspections, corrective measures shall be taken.

Dirk Brandenburger
Head of Department

beglaubigt:
Herschelmann

List of the liquids, the plastic sheet "Wolfin IB" is impermeable and chemically resistant to, for load level "high" (class S3) (this is equivalent to maximum admissible load duration up to 3 months):

Liquids	Media group
<ul style="list-style-type: none"> ▪ heating oil EL (according to DIN 51603-1) ▪ Unused combustion engine oils ▪ Unused vehicle gear oils ▪ Mixture of saturated and aromatic hydrocarbons with an aromatic content ≤ 20 wt.-% and a flash point > 55 °C 	3
Diesel fuel (according to EN 590) with a maximum of 5 vol.-% biodiesel fuel (according to EN 14214)	3a
Diesel fuel (according to EN 590) with a maximum of 20 vol.-% biodiesel fuel (according to EN 14214)	3b
<ul style="list-style-type: none"> ▪ used combustion engine oil and ▪ used automotive transmission oil with a flash point > 55 °C	4c
aqueous solutions of aliphatic aldehydes up to 40 %	8
mineral acids up to 20 % as well as acidic, hydrolyzing inorganic salts in aqueous solution (pH < 6), with exception of hydrofluoric acid and acids with an oxidizing effect and their salts	10
aqueous solutions of inorganic not oxidizing salts with a pH value between 6 and 8	12

Jet propulsion fuel Jet A1 with additives (Nato code F 34)
75% phosphoric acid (technically pure)
85% lactic acid
"OMV-crude oil mixture in a special composition "Crude oil oliv Greggier UN-Nummer 1267, WGK 3, VBF A1; Typ ES Sider / Sirtica / SYR L Dichte 842,2" with a density of the mixture of 842,2 kg/m ³ "

List of liquids, the plastic sheet "Wolfin IB" is impermeable and chemically resistant to, for load level "medium" (class S2) (this is equivalent to maximum admissible load duration up to 72 hours):

Liquids	Media group
aqueous solutions of organic acids (carboxylic acid) up to 10 % as well their salts (in aqueous solution)	9

"Wolfin IB"	Annex 1
List of liquids	

Product characteristics of "Wolfin IB"

Properties	Unit	Test procedure	Characteristic values
Thickness	mm	EN 1849-2	1.5 und 2.0 (+10 %/-5 %; single values ± 10 %)
Appearance	--	EN 1850-2	Free of defects, like bubbles, pores, rips, in homogeneities
Density	g/cm ³	EN ISO 1183-1	1.30 \pm 0.02
Tensile strength at break	MD	EN 12311-2 Test method B test speed v = 500 mm/min	18.0 \pm 15 %
	CMD		18.0 \pm 15 %
Elongation at break	MD		350 \pm 20 % (relative)
	CMD		350 \pm 20 % (relative)

Classes

Reaction to fire class 'E' according to EN 13501-1
Slipping behaviour in case of fire: class 'sb1' only for the combined mechanical and thermal fixing to the wall according to Annex 12

"Wolfin IB"	Annex 2
Product characteristics and classes	

Serial No.	Confirmation by the executing company	
1	Object	
2	Material on stock:.....	
3	Lining with (Trade name/Type/Thickness/Batch Number)	
4	Approval: ETA No:..... of (date):	
5a	Manufacturer of the plastic sheets: (holder of approval)	
5b	Executing company	
5c	Period of construction:	
		Confirmation
6	The specialized staff of the executing company was informed by the manufacturer of the plastic sheets about the adequate processing	
7	Judgment before producing the lining: a) Structural conditions according to ETA is given	
8	Control of the installation	
	a) Test certificates of the welders according to EN 13067 are available	
	b) Test records of welding are available (workshop/site)	
	c) If necessary: protective covering in accordance with ETA was applied	
	d) If necessary: arrangements to avoid ignition were realized (A description of the action had to attach to the confirmation.)	
Remarks:		

Date:
.....
(Company)

"Wolfin IB"	Annex 3
Confirmation by the executing company	

Collecting basins and collec
rooms inside as well as outs
of buildings for the storage of
liquids hazardous to water

Welding design and dimensions

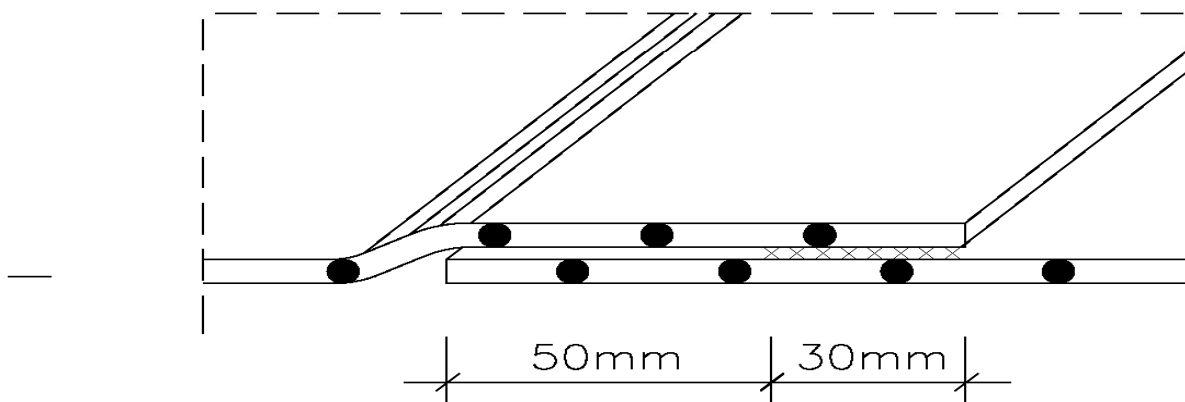

Lap joint without air-channel (single weld)

Scale: no scale

"Wolfin IB"	Annex 4
Welding design and dimensions	

Collecting basins outside of buildings for the storage of liquids hazardous to water with a protective gravel layer

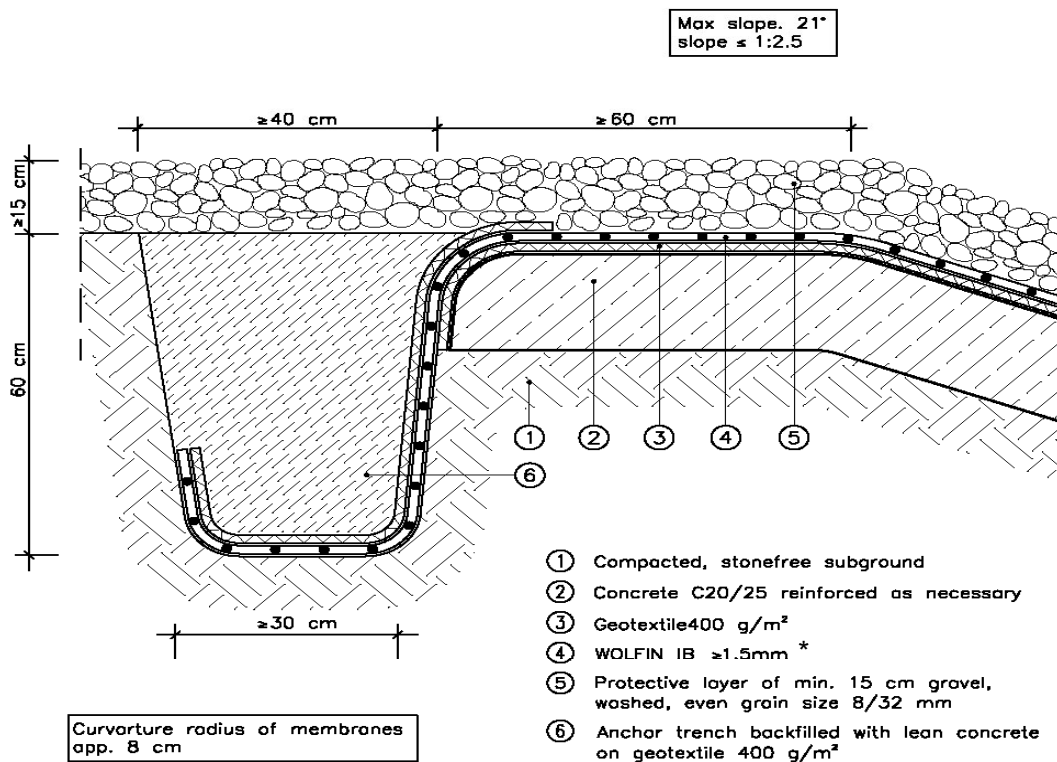

Standard anchor trench detail: dam crest

Scale: no scale

"Wolfin IB"	Annex 5
Collecting basins with a protective gravel layer – dam crest	

Collecting basins outside of buildings for the storage of liquids hazardous to water with a protective gravel layer

*: The protective layer is only accessible!

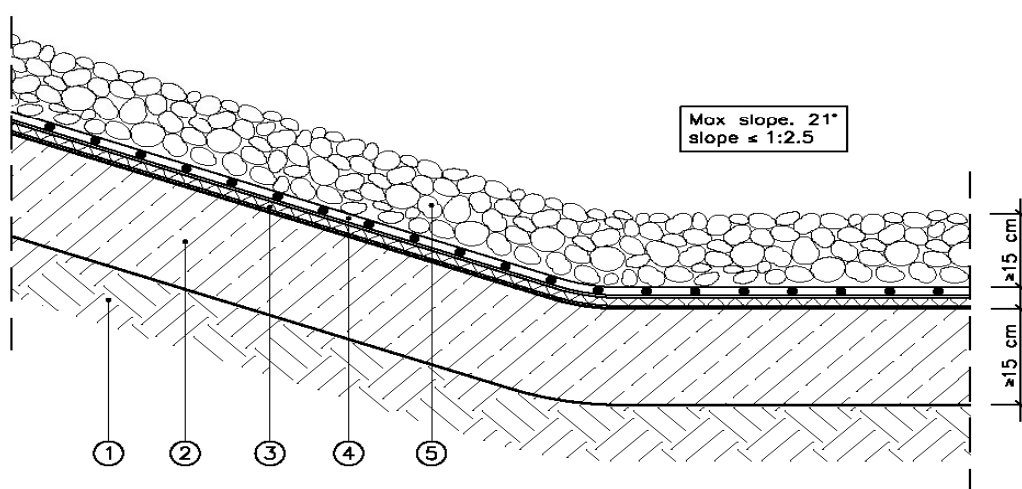

Curvature radius of membranes
app. 8 cm

- ① Compacted, stonefree subground
- ② Concrete C20/25 reinforced as necessary
- ③ Geotextile 400 g/m²
- ④ WOLFIN IB ≥1.5mm *
- ⑤ Protective layer of min. 15 cm gravel, washed, even grain size 8/32 mm

Standard detail: toe of slope and slope Ground

Scale: no scale

Electronic copy of the ETA by DIBt: ETA-10/0295

"Wolfin IB"	Annex 6
Collecting basins with a protective gravel layer – toe of slope and slope ground	

Collecting basins outside of buildings for the storage of liquids hazardous to water with a protective layer of concrete paving slabs or concrete blocks respectively

Max slope. 33°
slope ≤ 1:2.5

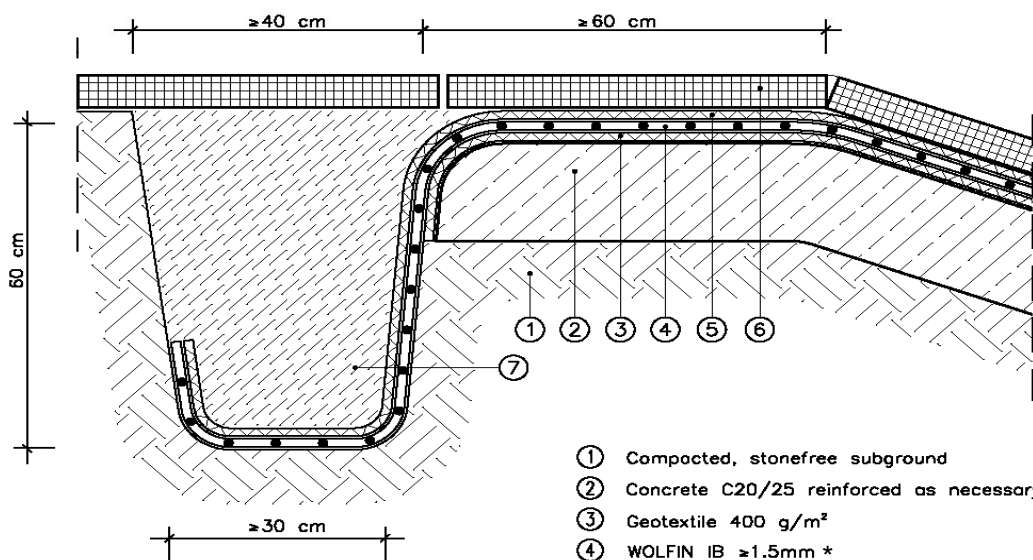

Curvature radius of membranes
app. 8 cm

- ① Compacted, stonefree subground
- ② Concrete C20/25 reinforced as necessary
- ③ Geotextile 400 g/m²
- ④ WOLFIN IB ≥1.5mm *
- ⑤ Geotextile 400 g/m²
- ⑥ Protective layer of concrete paving slabs or concrete blocks respectively
- ⑦ Anchor trench backfilled with lean concrete on geotextile 400 g/m²

*: The protective layer is only accessible!

Standard anchor trench detail: dam crest

Scale: no scale

"Wolfin IB"	Annex 7
Collecting basins with a protective layer of concrete paving slabs or concrete blocks – dam crest	

Collecting basins outside of buildings for the storage of liquids hazardous to water with a protective layer of concrete paving slabs or concrete blocks respectively

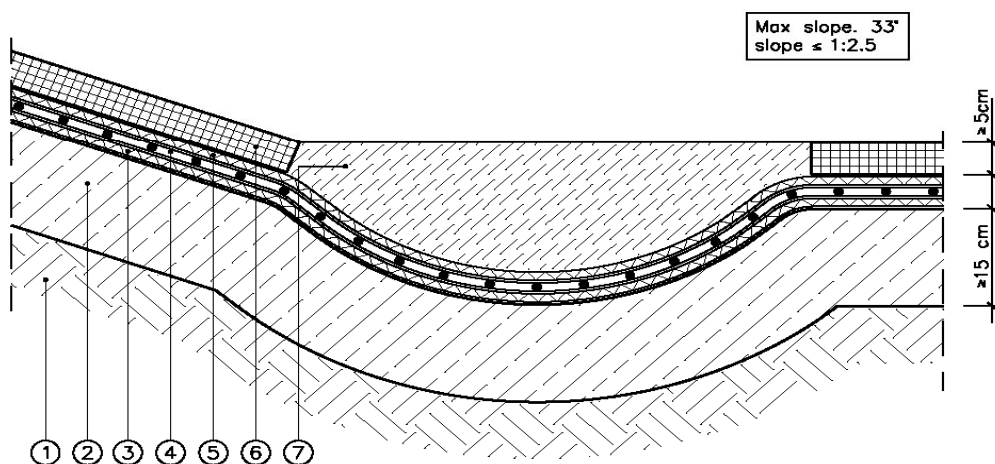

- ① Compacted, stonefree subground
- ② Concrete C20/25 reinforced as necessary
- ③ Geotextile 400 g/m² *
- ④ WOLFIB IB ≥ 1.5mm *
- ⑤ Geotextile 400 g/m²
- ⑥ Protective layer of concrete paving slabs or concrete blocks respectively
- ⑦ Site concrete counter bearing

Curvature radius of membranes
app. 8 cm

*: The protective layer is only accessible!

Standard detail: toe of slope and slope Ground

Scale: no scale

"Wolfib IB"	Annex 8
Collecting basins with a protective layer of concrete paving slabs or concrete blocks – toe of slope and slope ground	

Collecting basins inside of buildings for the storage of liquids hazardous to water with a protective layer

Ground floor: Cement screed
Walls: Beamfilling, plastered

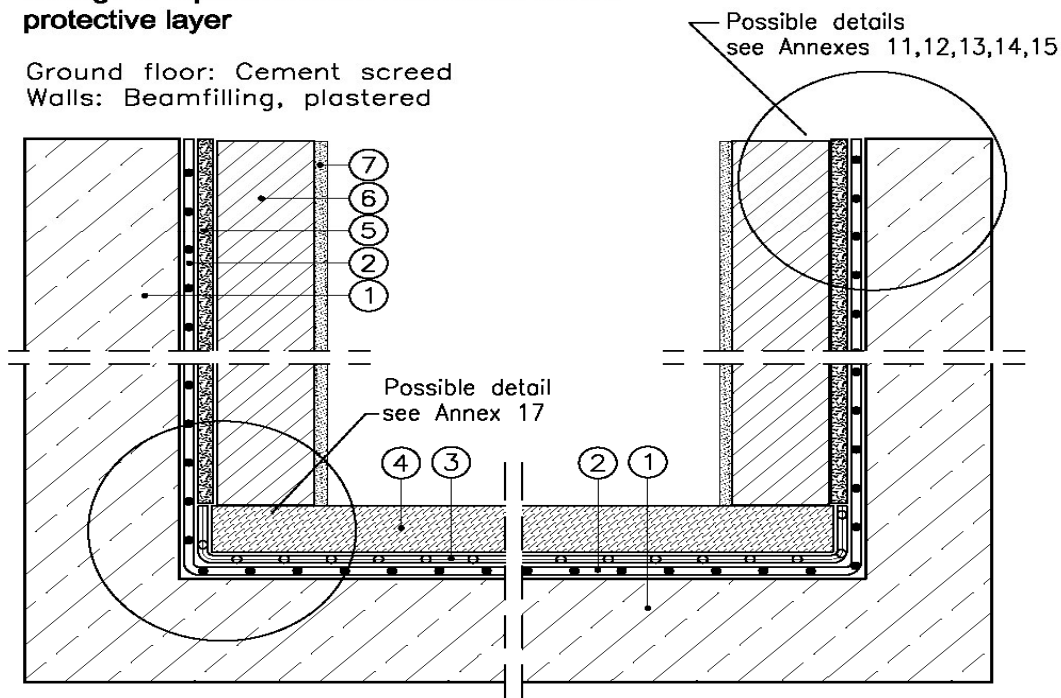

- ① Concrete of collecting room
- ② WOLFIN IB $\geq 1.5\text{mm}$ *
- ③ Polyethylene film, two-layer, each 0.2 mm
- ④ Cement screed ≥ 50 mm
- ⑤ Wood fiberboard or rubber granule board 1.5 mm thick respectively 2.0 mm
- ⑥ Beamfilling 115 mm
- ⑦ Plaster 20 mm

Run of lining depicted schematically

*: The protective layer is only accessible!

Scale: no scale

"Wolfin IB"	Annex 9
Collecting room with protective layer – beamfilling, plastered	

Collecting basins inside of buildings for the storage of liquids hazardous to water with a protective layer

Ground floor: Ceramic tiles
Walls: Ceramic tiles on concrete facing layer

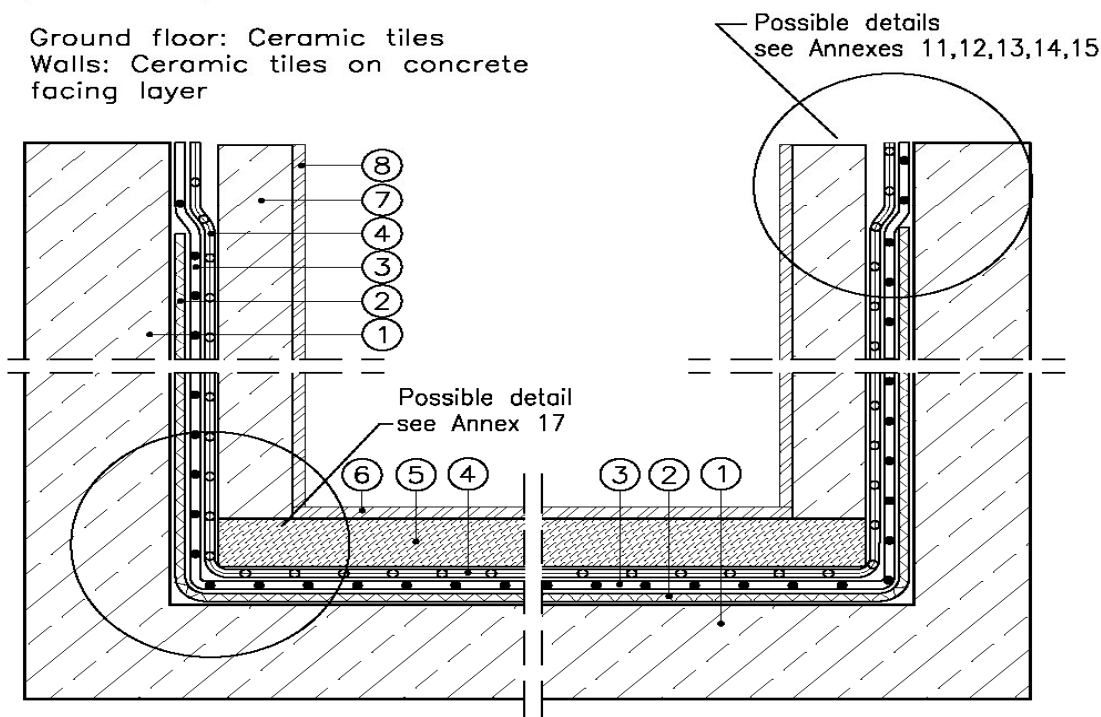

- ① Concrete of collecting room
- ② Geotextile 400 g/m²*
- ③ WOLFIB IB ≥1.5mm
- ④ Polyethylene film, two layers, each 0.2 mm
- ⑤ Cement screed ≥50 mm
- ⑥ Ceramic tiles
- ⑦ Concrete facing layer ≥100 mm
- ⑧ Ceramic tiles

Run of lining depicted schematically

* The protective layer is only accessible!

Scale: no scale

Electronic copy of the ETA by DIBt: ETA-10/0295

"Wolfib IB"	Annex 10
Collecting room with protective layer – Ceramic tiles	

Collecting basins inside of buildings for the storage of liquids hazardous to water

Upper end fixing with WOLFIN IB laminated metal strips on top of the wall

- ① Concrete of collecting room
 - ② Membrane WOLFIN IB ≥ 1.5 mm
 - ③ Anchorage ¹⁾ made of stainless steel according to ETA or according to the intended national provisions of the member states (taking into account the specific conditions e. g. effective anchorage depth, corrosion protection, spacings)
 - ④ Lap joint acc. Annex 4
 - ⑤ WOLFIN IB laminated metal strip, winding up 30 mm/ 70 mm, α = edge distance
- ¹⁾ in case of using approved plastic anchors only screws made of stainless steel are permitted

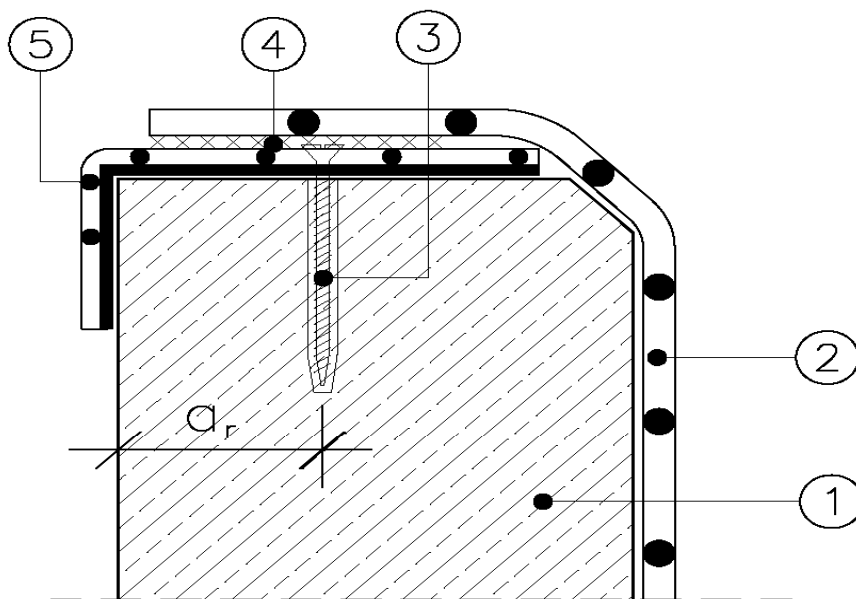

Scale: no scale

"Wolfin IB"	Annex 11
Upper end fixing with laminated metal strips on top of the wall	

Collecting basins inside of buildings for the storage of liquids hazardous to water

Upper end fixing: Combination of mechanically and thermally joint using WOLFIN IB laminated metal strips

- ① Concrete of collecting room
 - ② Membrane WOLFIN IB ≥ 1.5 mm
 - ③ WOLFIN IB laminated metal strip
 - ④ Anchorage ¹⁾ made of stainless steel according to ETA or according to the intended national provisions of the member states (taking into account the specific conditions e. g. effective anchorage depth, corrosion protection, spacings)
 - ⑤ Lap joint acc. Annex 4
 - ⑥ Sealing
- ¹⁾ in case of using approved plastic anchors only screws made of stainless steel are permitted

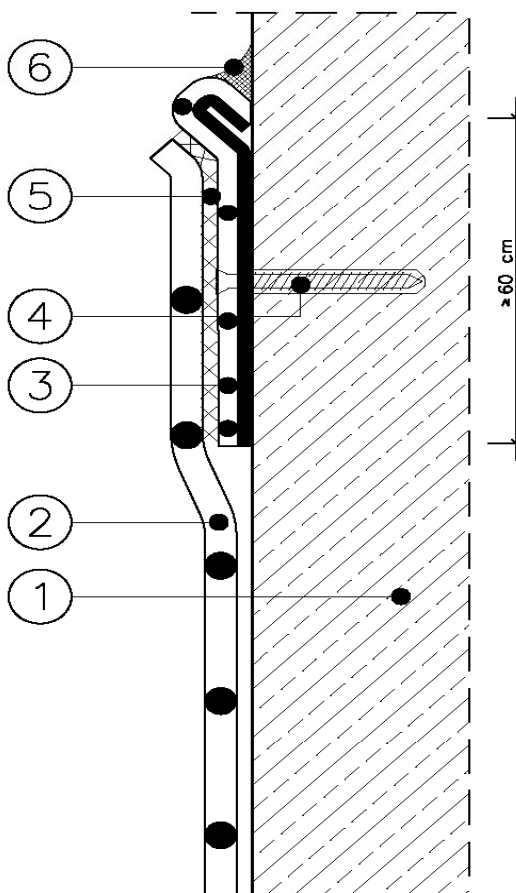

Scale: no scale

"Wolfin IB"	Annex 12
Upper end fixing with combination of mechanically and thermally joint	

Collecting basins inside of buildings for the storage of liquids hazardous to water

Upper end fixing: Thermally joint using WOLFIN IB waterstop type AF6

- ① Concrete of collecting room
- ② Membrane WOLFIN IB ≥ 1.5 mm
- ③ Lap joint acc. Annex 4
- ④ WOLFIN IB waterstop type AF6

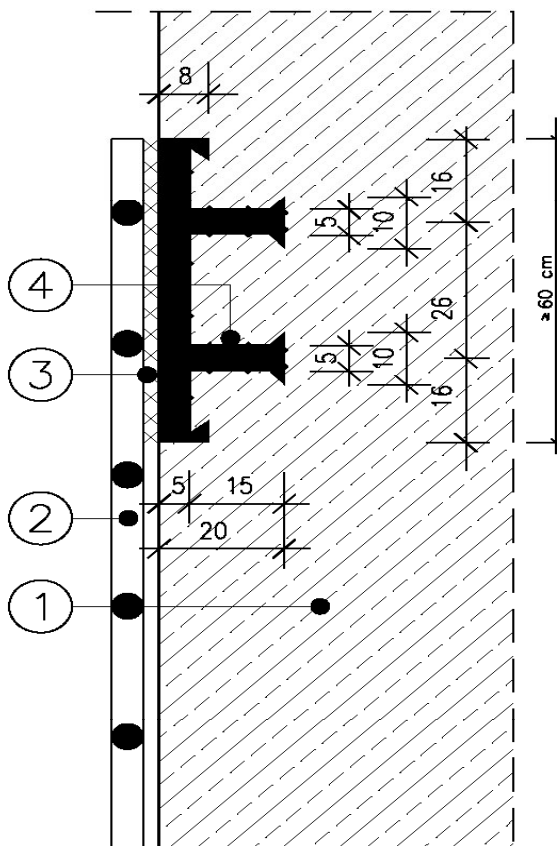

Scale: no scale

"Wolfin IB"	Annex 13
Upper end fixing with thermally joint	

Collecting basins inside of buildings for the storage of liquids hazardous to water

Upper end fixing: Mechanical
joint using flat sections and
anchors

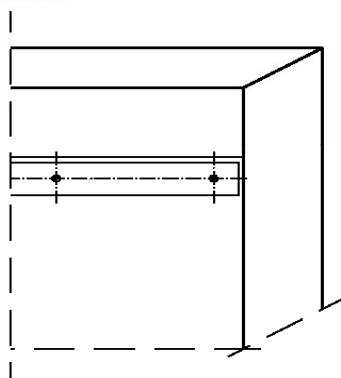

Dimensions see Annex 16

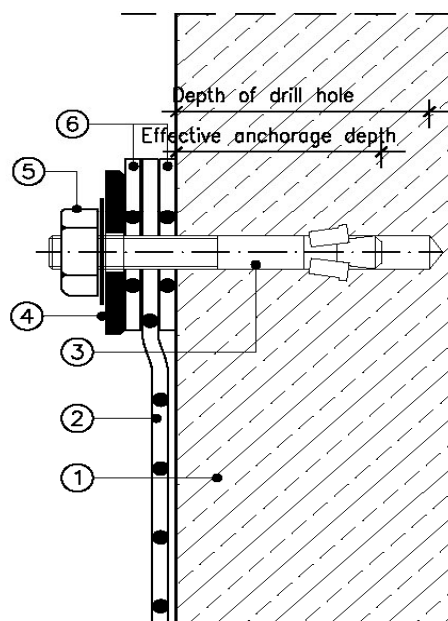

- ① Concrete of collecting room
 - ② Membrane WOLFIN IB ≥ 1.5 mm
 - ③ Anchorage ¹⁾ made of stainless steel according to ETA or according to the intended national provisions of the member states (taking into account the specific conditions e. g. effective anchorage depth, corrosion protection, spacings)
- ¹⁾ in case of using approved plastic anchors only screws made of stainless steel are permitted

- ④ Flat section FL 60x6 mm made of stainless steel according to the intended national provisions of the member states (in Germany: Z-30.3-6)
- ⑤ Seating torque = 25 Nm
- ⑥ Additional WOLFIN IB strips ≥ 1.5 mm

Scale: no scale

"Wolfin IB"	Annex 14
Mechanical joint using flat sections and anchors	

Collecting basins inside of buildings for the storage of liquids hazardous to water

Upper end fixing: Mechanical joint using flat sections and anchors

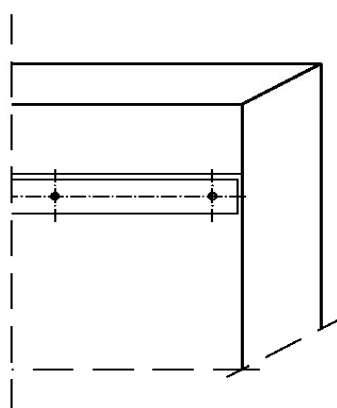

Dimensions see Annex 16

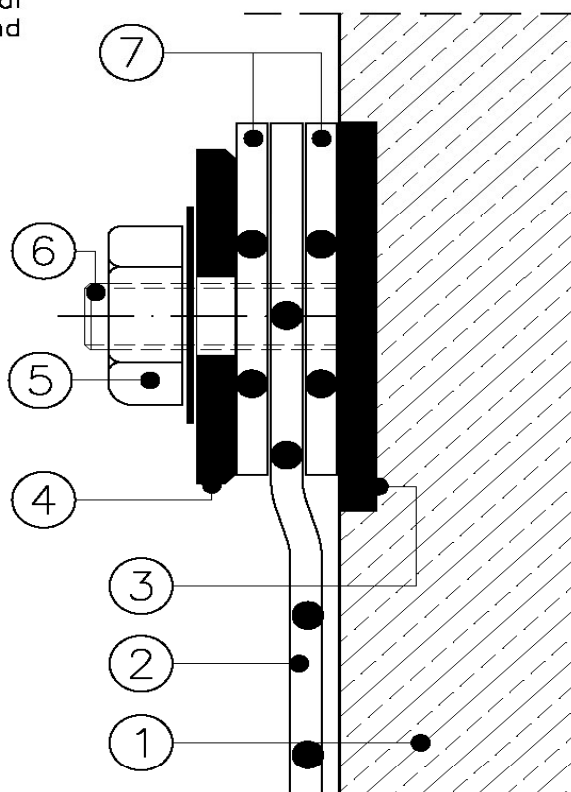

- ① Concrete of collecting room
- ② Membrane WOLFIB ≥ 1.5 mm
- ③ Flat section FL 70x6 mm made of stainless steel according to the intended national provisions of the member states (in Germany: Z-30.3-6)
- ④ Flat section FL 60x6 mm made of stainless steel according to the intended national provisions of the member states (in Germany: Z-30.3-6)

- ⑤ Seating torque = 25 Nm
- ⑥ Stay bolt $\varnothing \geq 12$ mm
- ⑦ Additional WOLFIB strips ≥ 1.5 mm

Scale: no scale

"Wolfin IB"	Annex 15
Mechanical joint	

**Collecting basins inside of buildings for the
storage of liquids hazardous to water**

Mechanically upper end
fixing of membranes

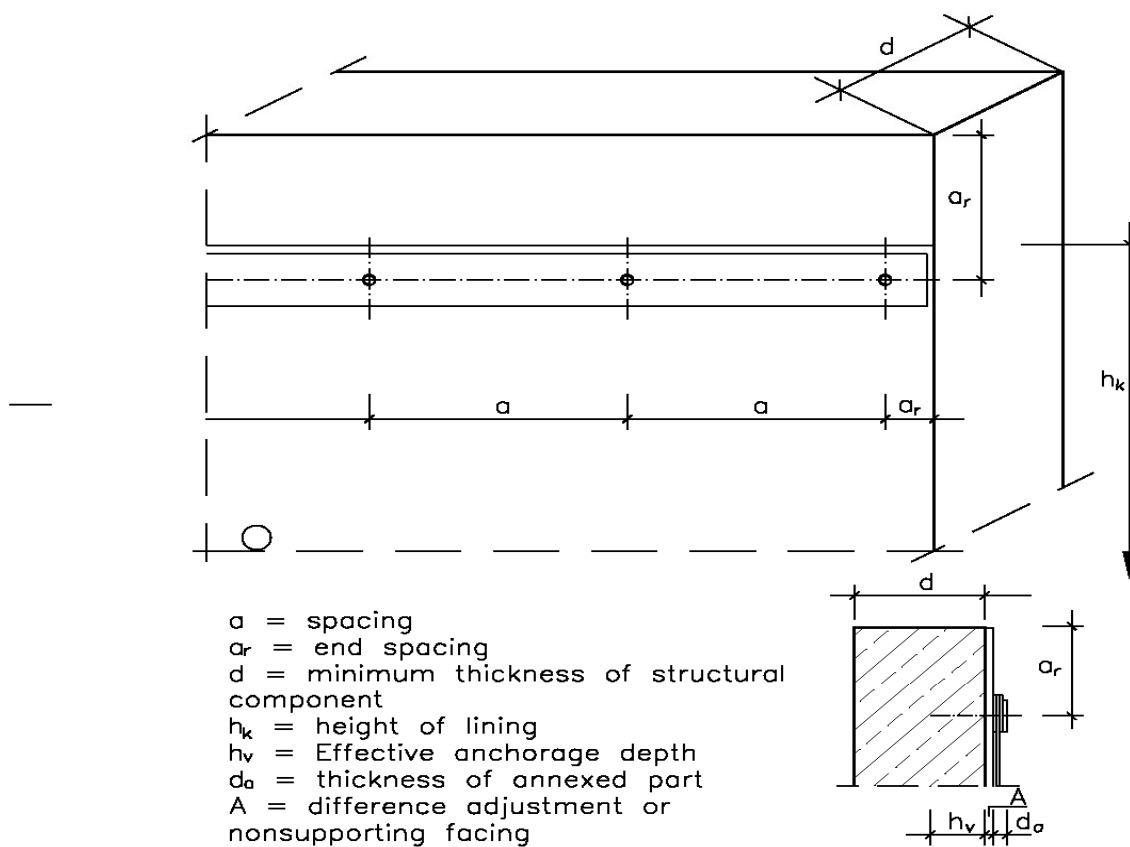

Scale: no scale

"Wolfin IB"	Annex 16
Dimensions for mechanically upper end fixing of plastic sheets	

Collecting basins inside of buildings for the storage of liquids hazardous to water

Fixing in vertical and horizontal corners
with WOLFEN IB laminated metal strips

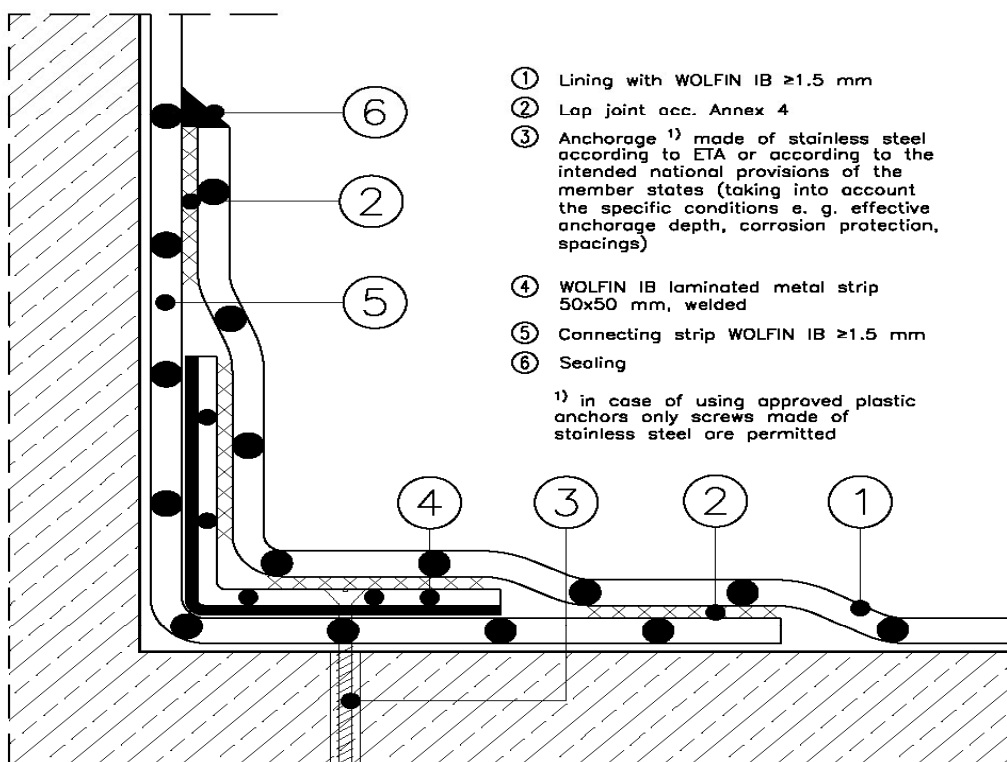

Scale: no scale

"Wolfen IB"	Annex 17
Fixing in corners inside of buildings	

Collecting basins inside of buildings for the storage of liquids hazardous to water

Linear fixing on walls with heights > 4.0 m: Combination of mechanically and thermally joint using WOLFIN IB laminated metal strip

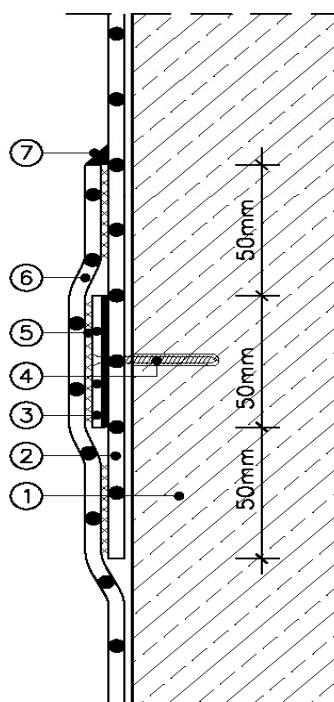
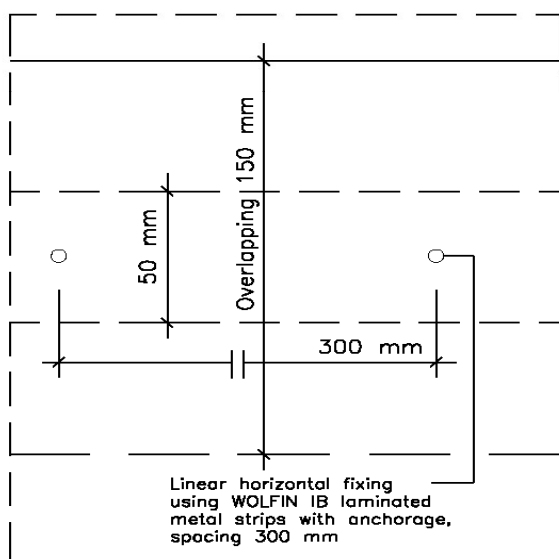

- ① Concrete of collecting room
- ② Membrane WOLFIN IB ≥ 1.5 mm
- ③ WOLFIN IB laminated metal strip, width 50 mm
- ④ Anchorage ¹⁾ made of stainless steel according to ETA or according to the intended national provisions of the member states (taking into account the specific conditions e. g. effective anchorage depth, corrosion protection, spacings)

- ⑤ Lap joint acc. Annex 4
- ⑥ Membrane WOLFIN IB ≥ 1.5 mm
- ⑦ Sealing

¹⁾ in case of using approved plastic anchors only screws made of stainless steel are permitted

Scale: no scale

"Wolfin IB"	Annex 18
Linear fixing on walls with heights > 4.0 m	