

Public-law institution jointly founded by the federal states and the Federation

European Technical Assessment Body
for construction products



European Technical Assessment

ETA-24/0045
of 26 April 2024

English translation prepared by DIBt - Original version in German language

General Part

Technical Assessment Body issuing the European Technical Assessment:

Deutsches Institut für Bautechnik

Trade name of the construction product

ABS Injection System UM-H for concrete

Product family to which the construction product belongs

Bonded fasteners and bonded expansion fasteners for use in concrete

Manufacturer

ABS Safety GmbH
Gewerbering 3
47623 Kevelaer

Manufacturing plant

Plant 1

This European Technical Assessment contains

43 pages including 3 annexes which form an integral part of this assessment

This European Technical Assessment is issued in accordance with Regulation (EU) No 305/2011, on the basis of

EAD 330499-02-0601, Edition 11/2023

The European Technical Assessment is issued by the Technical Assessment Body in its official language. Translations of this European Technical Assessment in other languages shall fully correspond to the original issued document and shall be identified as such.

Communication of this European Technical Assessment, including transmission by electronic means, shall be in full. However, partial reproduction may only be made with the written consent of the issuing Technical Assessment Body. Any partial reproduction shall be identified as such.

This European Technical Assessment may be withdrawn by the issuing Technical Assessment Body, in particular pursuant to information by the Commission in accordance with Article 25(3) of Regulation (EU) No 305/2011.

Specific Part

1 Technical description of the product

The "ABS Injection system UM-H for concrete" is a bonded anchor consisting of a cartridge with injection mortar ABS UM-H and a steel element according to Annex A 3 and A 5.

The steel element is placed into a drilled hole filled with injection mortar and is anchored via the bond between metal part, injection mortar and concrete.

The product description is given in Annex A.

2 Specification of the intended use in accordance with the applicable European Assessment Document

The performances given in Section 3 are only valid if the anchor is used in compliance with the specifications and conditions given in Annex B.

The verifications and assessment methods on which this European Technical Assessment is based lead to the assumption of a working life of the anchor of at least 50 and/or 100 years. The indications given on the working life cannot be interpreted as a guarantee given by the producer, but are to be regarded only as a means for choosing the right products in relation to the expected economically reasonable working life of the works.

3 Performance of the product and references to the methods used for its assessment

3.1 Mechanical resistance and stability (BWR 1)

Essential characteristic	Performance
Characteristic resistance to tension load (static and quasi-static loading)	See Annex C 1 to C 4, C 6 to C 7, C 9 to C 10, B 3
Characteristic resistance to shear load (static and quasi-static loading)	See Annex C 1, C 5, C 8, C 11
Displacements under short-term and long-term loading	See Annex C 12 to C 14
Characteristic resistance and displacements for seismic performance categories C1 and C2	See Annex C 15 to C 23

3.2 Safety in case of fire (BWR 2)

Essential characteristic	Performance
Reaction to fire	Class A1
Resistance to fire	See Annex C 24 to C 26

3.3 Hygiene, health and the environment (BWR 3)

Essential characteristic	Performance
Content, emission and/or release of dangerous substances	No performance assessed

4 Assessment and verification of constancy of performance (AVCP) system applied, with reference to its legal base

In accordance with EAD 330499-02-0601 the applicable European legal act is: [96/582/EC].

The system to be applied is: 1

5 Technical details necessary for the implementation of the AVCP system, as provided for in the applicable European Assessment Document

Technical details necessary for the implementation of the AVCP system are laid down in the control plan deposited at Deutsches Institut für Bautechnik.

Issued in Berlin on 26 April 2024 by Deutsches Institut für Bautechnik

Dipl.-Ing. Beatrix Wittstock
Head of Section

beglaubigt:
Baderschneider

Installation threaded rod M8 up to M30

prepositioned installation or
push through installation (annular gap filled with mortar)

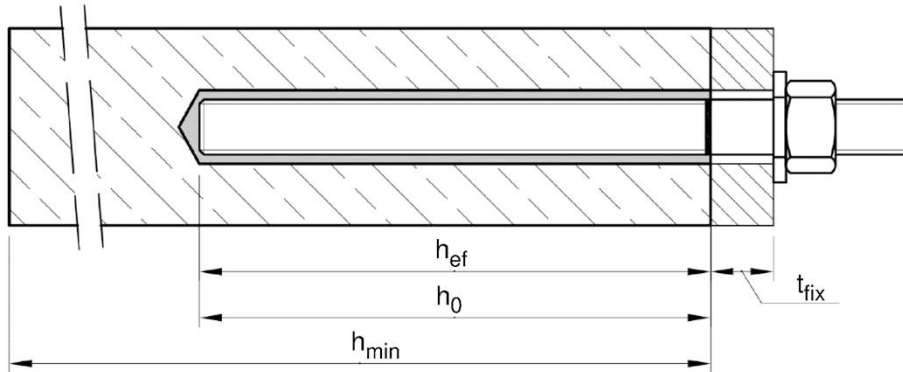

Installation reinforcing bar Ø8 up to Ø32

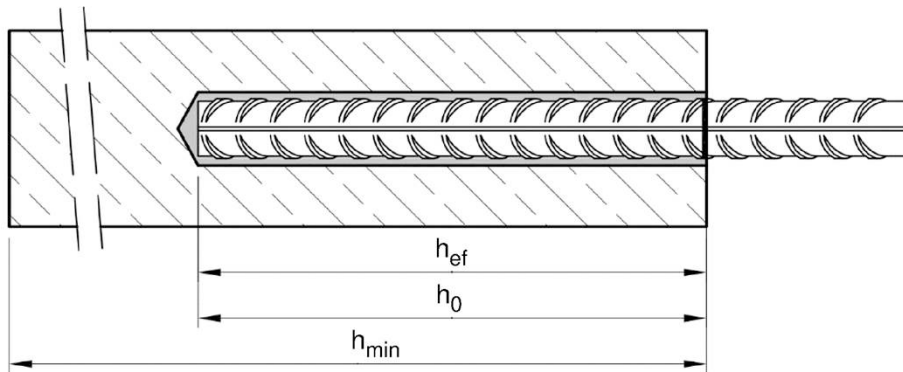

Installation internal threaded anchor rod IG-M6 up to IG-M20

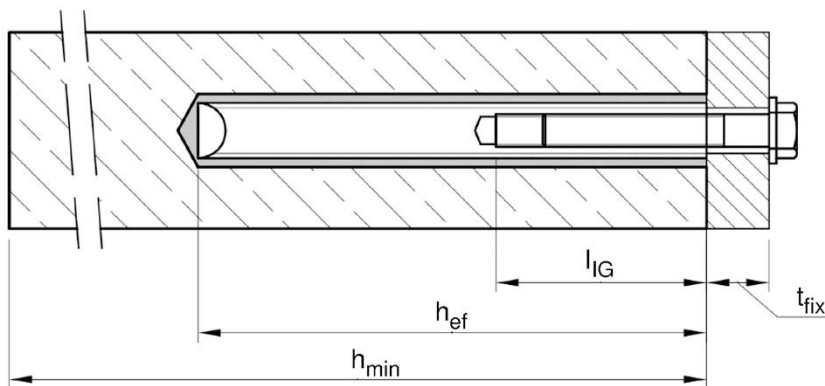

t_{fix} = thickness of fixture
 h_{ef} = effective embedment depth
 h_{min} = minium thickness of member

h_0 = drill hole depth
 l_{IG} = thread engagement length

ABS Injection System UM-H for concrete

Product description
Installed condition

Annex A 1

Cartridge system

Coaxial Cartridge:

150 ml, 280 ml, 300 ml up to 333 ml and 380 ml up to 420 ml

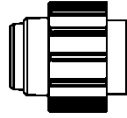

Imprint: ABS UM-H

Processing and safety instructions, shelf life, charge number, manufacturer's information, quantity information

Side-by-Side Cartridge:

235 ml, 345 ml up to 360 ml and 825 ml

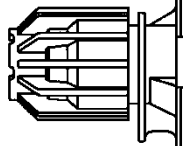

Imprint: ABS UM-H

Processing and safety instructions, shelf life, charge number, manufacturer's information, quantity information

Static mixer PM-19E

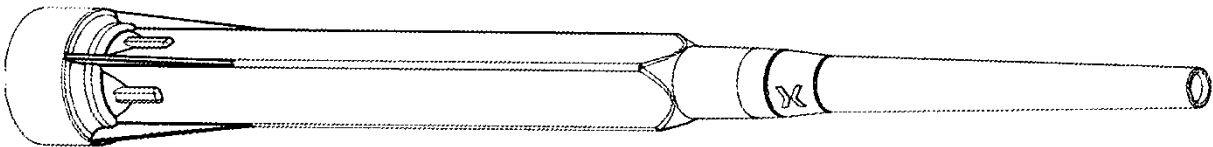

Piston plug VS and mixer extension VL

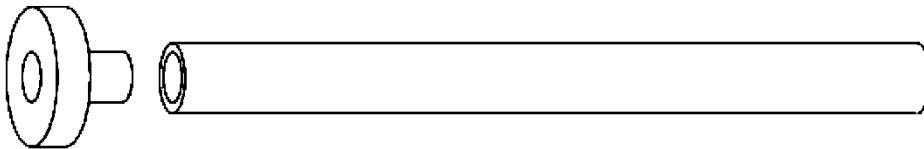

ABS Injection System UM-H for concrete

Product description
Injection system

Annex A 2

Threaded rod M8 up to M30 with washer and hexagon nut

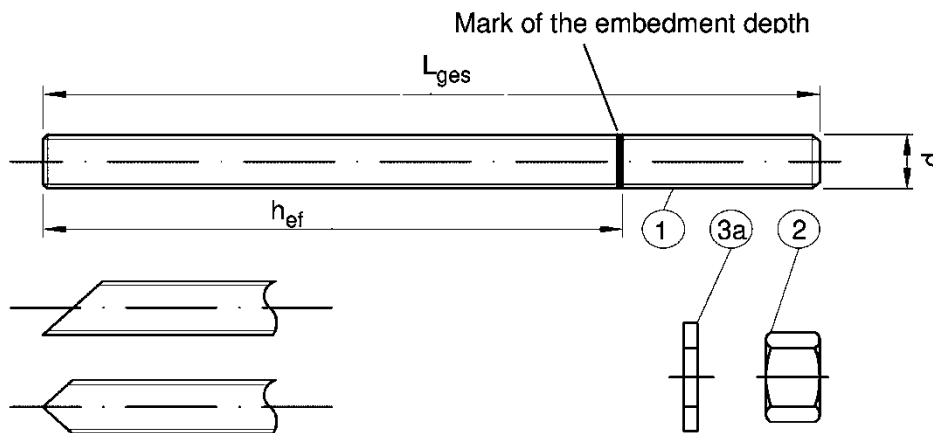



Commercial standard rod with:

- Materials, dimensions and mechanical properties acc. to Table A1
- Inspection certificate 3.1 acc. to EN 10204:2004. The document shall be stored.
- Marking of embedment depth

Internal threaded rod IG-M6 to IG-M20

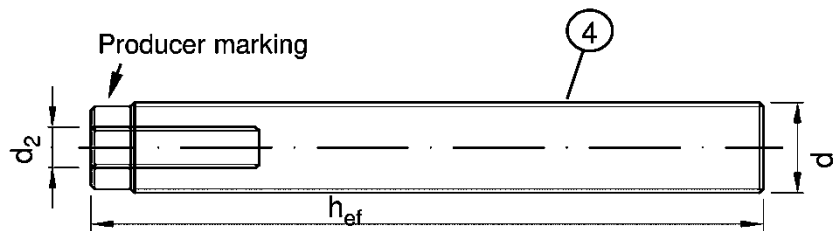
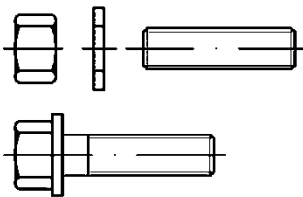
Threaded rod or screw



Producer marking: e.g.  M8

 Marking Internal thread

 Mark

M8 Thread size (Internal thread)

A4 additional mark for stainless steel

HCR additional mark for high-corrosion resistance steel

Filling washer VFS

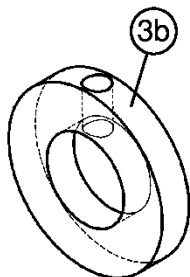

Mixer reduction nozzle MR

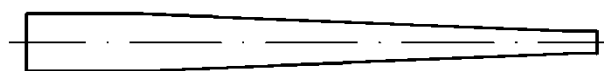

ABS Injection System UM-H for concrete

Product description

Threaded rod; Internal threaded rod
Filling washer; Mixer reduction nozzle

Annex A 3

Table A1: Materials						
Part	Designation	Material				
Steel, zinc plated (Steel acc. to EN ISO 683-4:2018 or EN 10263:2017)						
- zinc plated $\geq 5 \mu\text{m}$ acc. to EN ISO 4042:2022 or						
- hot-dip galvanised $\geq 40 \mu\text{m}$ acc. to EN ISO 1461:2022 and EN ISO 10684:2004+AC:2009 or						
- sherardized $\geq 45 \mu\text{m}$ acc. to EN ISO 17668:2016						
1	Threaded rod	Property class	Characteristic steel ultimate tensile strength	Characteristic steel yield strength	Elongation at fracture	
		acc. to EN ISO 898-1:2013	4.6	$f_{uk} = 400 \text{ N/mm}^2$	$f_{yk} = 240 \text{ N/mm}^2$	$A_5 > 8\%$
			4.8	$f_{uk} = 400 \text{ N/mm}^2$	$f_{yk} = 320 \text{ N/mm}^2$	$A_5 > 8\%$
			5.6	$f_{uk} = 500 \text{ N/mm}^2$	$f_{yk} = 300 \text{ N/mm}^2$	$A_5 > 8\%$
			5.8	$f_{uk} = 500 \text{ N/mm}^2$	$f_{yk} = 400 \text{ N/mm}^2$	$A_5 > 8\%$
8.8	$f_{uk} = 800 \text{ N/mm}^2$	$f_{yk} = 640 \text{ N/mm}^2$	$A_5 \geq 12\%$ ³⁾			
2	Hexagon nut	acc. to EN ISO 898-2:2022	4	for anchor rod class 4.6 or 4.8		
			5	for anchor rod class 5.6 or 5.8		
			8	for anchor rod class 8.8		
3a	Washer	Steel, zinc plated, hot-dip galvanised or sherardized (e.g.: EN ISO 887:2006, EN ISO 7089:2000, EN ISO 7093:2000 or EN ISO 7094:2000)				
3b	Filling washer	Steel, zinc plated, hot-dip galvanised or sherardized				
4	Internal threaded anchor rod	Property class	Characteristic steel ultimate tensile strength	Characteristic steel yield strength	Elongation at fracture	
		acc. to EN ISO 898-1:2013	5.8	$f_{uk} = 500 \text{ N/mm}^2$	$f_{yk} = 400 \text{ N/mm}^2$	$A_5 > 8\%$
			8.8	$f_{uk} = 800 \text{ N/mm}^2$	$f_{yk} = 640 \text{ N/mm}^2$	$A_5 > 8\%$
Stainless steel A2 (Material 1.4301 / 1.4307 / 1.4311 / 1.4567 or 1.4541, acc. to EN 10088-1:2014)						
Stainless steel A4 (Material 1.4401 / 1.4404 / 1.4571 / 1.4362 or 1.4578, acc. to EN 10088-1:2014)						
High corrosion resistance steel (Material 1.4529 or 1.4565, acc. to EN 10088-1: 2014)						
1	Threaded rod ¹⁾⁴⁾	Property class	Characteristic steel ultimate tensile strength	Characteristic steel yield strength	Elongation at fracture	
		acc. to EN ISO 3506-1:2020	50	$f_{uk} = 500 \text{ N/mm}^2$	$f_{yk} = 210 \text{ N/mm}^2$	$A_5 \geq 8\%$
			70	$f_{uk} = 700 \text{ N/mm}^2$	$f_{yk} = 450 \text{ N/mm}^2$	$A_5 \geq 12\%$ ³⁾
80	$f_{uk} = 800 \text{ N/mm}^2$	$f_{yk} = 600 \text{ N/mm}^2$	$A_5 \geq 12\%$ ³⁾			
2	Hexagon nut ¹⁾⁴⁾	acc. to EN ISO 3506-1:2020	50	for anchor rod class 50		
			70	for anchor rod class 70		
			80	for anchor rod class 80		
3a	Washer	A2: Material 1.4301 / 1.4307 / 1.4311 / 1.4567 or 1.4541, acc. to EN 10088-1:2014 A4: Material 1.4401 / 1.4404 / 1.4571 / 1.4362 or 1.4578, acc. to EN 10088-1:2014 HCR: Material 1.4529 or 1.4565, acc. to EN 10088-1: 2014 (e.g.: EN ISO 887:2006, EN ISO 7089:2000, EN ISO 7093:2000 or EN ISO 7094:2000)				
3b	Filling washer	Stainless steel A4, High corrosion resistance steel				
4	Internal threaded anchor rod ¹⁾²⁾	Property class	Characteristic steel ultimate tensile strength	Characteristic steel yield strength	Elongation at fracture	
		acc. to EN ISO 3506-1:2020	50	$f_{uk} = 500 \text{ N/mm}^2$	$f_{yk} = 210 \text{ N/mm}^2$	$A_5 > 8\%$
		70	$f_{uk} = 700 \text{ N/mm}^2$	$f_{yk} = 450 \text{ N/mm}^2$	$A_5 > 8\%$	
1) Property class 70 or 80 for anchor rods and hexagon nuts up to M24 and Internal threaded anchor rods up to IG-M16						
2) for IG-M20 only property class 50						
3) $A_5 > 8\%$ fracture elongation if no use for seismic performance category C2						
4) Property class 80 only for stainless steel A4 and HCR						
ABS Injection System UM-H for concrete				Annex A 4		
Product description Materials threaded rod and internal threaded rod						

Reinforcing bar: $\varnothing 8$ up to $\varnothing 32$

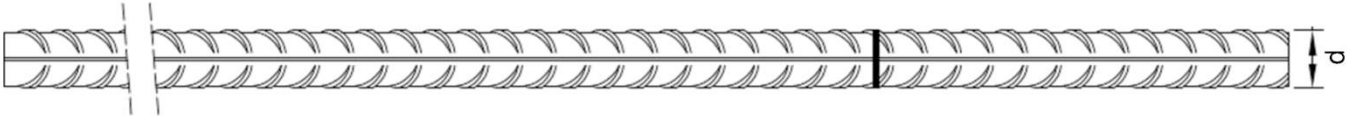

Minimum value of related rip area $f_{R,min}$ according to EN 1992-1-1:2004+AC:2010

Rib height of the bar shall be in the range $0,05d \leq h_{rib} \leq 0,07d$

(d: Nominal diameter of the bar; h_{rib} : Rib height of the bar)

Table A2: Materials Reinforcing bar

Part	Designation	Material
Rebar		
1	Reinforcing steel according to EN 1992 1 1:2004+AC:2010, Annex C	Bars and rebars from ring class B or C f_{yk} and k according to NDP or NCI according to EN 1992-1-1/NA $f_{uk} = f_{tk} = k \cdot f_{yk}$

ABS Injection System UM-H for concrete

Product description
Materials reinforcing bar

Annex A 5

Specification of the intended use				
Fasteners subject to (Static and quasi-static loads):				
	Working life 50 years		Working life 100 years	
Base material	uncracked concrete	cracked concrete	uncracked concrete	cracked concrete
HD: Hammer drilling HDB: Hammer drilling with hollow drill bit CD: Compressed air drilling	M8 to M30, Ø8 to Ø32, IG-M6 to IG-M20		M8 to M30, Ø8 to Ø32, IG-M6 to IG-M20	
Temperature Range:	I: - 40 °C to +40 °C ¹⁾ II: - 40 °C to +80 °C ²⁾ III: - 40 °C to +120 °C ³⁾ IV: - 40 °C to +160 °C ⁴⁾		I: - 40 °C to +40 °C ¹⁾ II: - 40 °C to +80 °C ²⁾	
Fasteners subject to (seismic action):				
	Performance Category C1		Performance Category C2	
Base material	Cracked and uncracked concrete			
HD: Hammer drilling HDB: Hammer drilling with hollow drill bit CD: Compressed air drilling	M8 to M30, Ø8 to Ø32		M12 to M24	
Temperature Range:	I: - 40 °C to +40 °C ¹⁾ II: - 40 °C to +80 °C ²⁾ III: - 40 °C to +120 °C ^{3) 5)} IV: - 40 °C to +160 °C ^{4) 5)}		I: - 40 °C to +40 °C ¹⁾ II: - 40 °C to +80 °C ²⁾ III: - 40 °C to +120 °C ^{3) 5)} IV: - 40 °C to +160 °C ^{4) 5)}	
Fasteners subject to (Fire exposure):				
Base material	uncracked and cracked concrete			
HD: Hammer drilling HDB: Hammer drilling with hollow drill bit CD: Compressed air drilling	M8 to M30, Ø8 to Ø32, IG-M6 to IG-M20			
Temperature Range:	I: - 40 °C to +40 °C ¹⁾ II: - 40 °C to +80 °C ²⁾ III: - 40 °C to +120 °C ³⁾ IV: - 40 °C to +160 °C ⁴⁾			
<p>1) (max. long-term temperature +24°C and max. short-term temperature +40°C) 2) (max. long-term temperature +50°C and max. short-term temperature +80°C) 3) (max. long-term temperature +72°C and max. short-term temperature +120°C) 4) (max. long-term temperature +100°C and max. short-term temperature +160°C) 5) Only for working life of 50 years</p>				
ABS Injection System UM-H for concrete				Annex B 1
Intended use Specifications				

Base materials:

- Compacted, reinforced or unreinforced normal weight concrete without fibres according to EN 206:2013 + A2:2021.
- Strength classes C20/25 to C50/60 according to EN 206:2013 + A2:2021.

Use conditions (Environmental conditions):

- Structures subject to dry internal conditions (all materials).
- For all other conditions according to EN 1993-1-4:2006+ A2:2020 corresponding to corrosion resistance class:
 - Stainless steel Stahl A2 according to Annex A 4, Table A1: CRC II
 - Stainless steel Stahl A4 according to Annex A 4, Table A1: CRC III
 - High corrosion resistance steel HCR according to Annex A 4, Table A1: CRC V

Design:

- Verifiable calculation notes and drawings are prepared taking account of the loads to be anchored. The position of the fastener is indicated on the design drawings (e. g. position of the fastener relative to reinforcement or to supports, etc.).
- Fasteners are designed under the responsibility of an engineer experienced in fasteners and concrete work.
- The fasteners are designed in accordance to EN 1992-4:2018 and Technical Report TR 055, Edition February 2018
- The fasteners under fire exposure are designed in accordance to Technical Report TR 082, Edition June 2023.

Installation:

- Dry, wet concrete or flooded bore holes (not sea-water).
- Hole drilling by hammer (HD), hollow (HDB) or compressed air (CD).
- Overhead installation allowed.
- Fastener installation carried out by appropriately qualified personnel and under the supervision of the person responsible for technical matters of the site.
- Installation temperature in concrete:
-5°C up to +40°C for the standard variation of temperature after installation.

ABS Injection System UM-H for concrete

Intended use
Specifications (Continued)

Annex B 2

Threaded rod			M8	M10	M12	M16	M20	M24	M27	M30
Diameter of element	$d = d_{nom}$	[mm]	8	10	12	16	20	24	27	30
Nominal drill hole diameter	d_0	[mm]	10	12	14	18	22	28	30	35
Effective embedment depth	$h_{ef,min}$	[mm]	60	60	70	80	90	96	108	120
	$h_{ef,max}$	[mm]	160	200	240	320	400	480	540	600
Diameter of clearance hole in the fixture ¹⁾	Prepositioned installation $d_f \leq$	[mm]	9	12	14	18	22	26	30	33
	Push through installation d_f	[mm]	12	14	16	20	24	30	33	40
Maximum installation torque	$\max T_{inst}$	[Nm]	10	20	40 ²⁾	60	100	170	250	300
Minimum thickness of member	h_{min}	[mm]	$h_{ef} + 30 \text{ mm} \geq 100 \text{ mm}$			$h_{ef} + 2d_0$				
Minimum spacing	s_{min}	[mm]	40	50	60	75	95	115	125	140
Minimum edge distance	c_{min}	[mm]	35	40	45	50	60	65	75	80

1) For application under seismic loading the diameter of clearance hole in the fixture shall be at maximum $d_1 + 1 \text{ mm}$ or alternatively the annular gap between fixture and threaded rod shall be filled force-fit with mortar.

2) Maximum installation torque for M12 with steel Grade 4.6 is 35 Nm

Reinforcing bar			$\emptyset 8^1)$	$\emptyset 10^1)$	$\emptyset 12^1)$	$\emptyset 14$	$\emptyset 16$	$\emptyset 20$	$\emptyset 24^1)$	$\emptyset 25^1)$	$\emptyset 28$	$\emptyset 32$
Diameter of element	$d = d_{nom}$	[mm]	8	10	12	14	16	20	24	25	28	32
Nominal drill hole diameter	d_0	[mm]	10 12	12 14	14 16	18	20	25	30 32	30 32	35	40
Effective embedment depth	$h_{ef,min}$	[mm]	60	60	70	75	80	90	96	100	112	128
	$h_{ef,max}$	[mm]	160	200	240	280	320	400	480	500	560	640
Minimum thickness of member	h_{min}	[mm]	$h_{ef} + 30 \text{ mm} \geq 100 \text{ mm}$			$h_{ef} + 2d_0$						
Minimum spacing	s_{min}	[mm]	40	50	60	70	75	95	120	120	130	150
Minimum edge distance	c_{min}	[mm]	35	40	45	50	50	60	70	70	75	85

1) both nominal drill hole diameter can be used

Internal threaded anchor rod			IG-M6	IG-M8	IG-M10	IG-M12	IG-M16	IG-M20
Internal diameter of anchor rod	d_2	[mm]	6	8	10	12	16	20
Outer diameter of anchor rod ¹⁾	$d = d_{nom}$	[mm]	10	12	16	20	24	30
Nominal drill hole diameter	d_0	[mm]	12	14	18	22	28	35
Effective embedment depth	$h_{ef,min}$	[mm]	60	70	80	90	96	120
	$h_{ef,max}$	[mm]	200	240	320	400	480	600
Diameter of clearance hole in the fixture	$d_f \leq$	[mm]	7	9	12	14	18	22
Maximum installation torque	$\max T_{inst}$	[Nm]	10	10	20	40	60	100
Thread engagement length min/max	l_{IG}	[mm]	8/20	8/20	10/25	12/30	16/32	20/40
Minimum thickness of member	h_{min}	[mm]	$h_{ef} + 30 \text{ mm} \geq 100 \text{ mm}$			$h_{ef} + 2d_0$		
Minimum spacing	s_{min}	[mm]	50	60	75	95	115	140
Minimum edge distance	c_{min}	[mm]	40	45	50	60	65	80

1) With metric threads

ABS Injection System UM-H for concrete	Annex B 3
Intended use Installation parameters	

Table B4: Parameter cleaning and installation tools

Threaded Rod	Re-inforcing bar	Internal threaded anchor rod	Drill bit - Ø HD, HDB, CD	Brush - Ø		Piston plug	Installation direction and use of piston plug			
				d_b	$d_{b,min}$ min.		↓	→	↑	
[mm]	[mm]	[mm]	[mm]		[mm]	[mm]				
M8	8		10	RB10	11,5	10,5	No plug required			
M10	8 / 10	IG-M6	12	RB12	13,5	12,5				
M12	10 / 12	IG-M8	14	RB14	15,5	14,5				
	12		16	RB16	17,5	16,5				
M16	14	IG-M10	18	RB18	20,0	18,5	VS18	$h_{ef} > 250$ mm	$h_{ef} > 250$ mm	all
	16		20	RB20	22,0	20,5	VS20			
M20		IG-M12	22	RB22	24,0	22,5	VS22			
	20		25	RB25	27,0	25,5	VS25			
M24		IG-M16	28	RB28	30,0	28,5	VS28			
M27	24 / 25		30	RB30	31,8	30,5	VS30			
	24 / 25		32	RB32	34,0	32,5	VS32			
M30	28	IG-M20	35	RB35	37,0	35,5	VS35			
	32		40	RB40	43,5	40,5	VS40			

Cleaning and installation tools

HDB – Hollow drill bit system



The hollow drill system consists of Heller Duster Expert hollow drill bit and a class M vacuum cleaner with a minimum negative pressure of 253 hPa and a flow rate of minimum 150 m³/h (42 l/s).

Hand pump

(Volume 750 ml, $h_0 \leq 10 d_s$, $d_0 \leq 20$ mm)



Compressed air tool

(min 6 bar)



Brush RB



Piston Plug VS



Brush extension RBL



ABS Injection System UM-H for concrete

Intended use

Cleaning and setting tools

Annex B 4

Table B5: Working time and curing time

Temperature in base material			Maximum working time	Minimum curing time ¹⁾
T			t _{work}	t _{cure}
- 5 °C	to	- 1 °C	50 min	5 h
0 °C	to	+ 4 °C	25 min	3,5 h
+ 5 °C	to	+ 9 °C	15 min	2 h
+ 10 °C	to	+ 14 °C	10 min	1 h
+ 15 °C	to	+ 19 °C	6 min	40 min
+ 20 °C	to	+ 29 °C	3 min	30 min
+ 30 °C	to	+ 40 °C	2 min	30 min
Cartridge temperature			+5°C to +40°C	

¹⁾ The minimum curing time is only valid for dry base material.
In wet base material the curing time must be doubled.

ABS Injection System UM-H for concrete

Intended use
Working time and curing time

Annex B 5

Installation instructions

Drilling of the bore hole

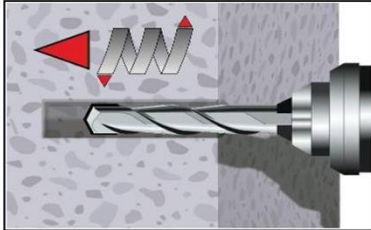

1a. Hammer drilling (HD) / Compressed air drilling (CD)

Drill a hole to the required embedment depth.
Drill bit diameter according to Table B1, B2 or B3.
Aborted drill holes shall be filled with mortar.
Proceed with Step 2 (MAC or CAC).

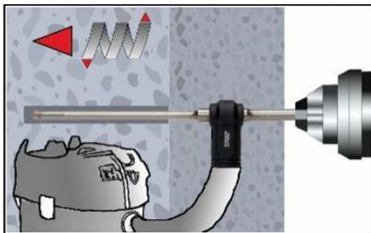

1b. Hollow drill bit system (HDB) (see Annex B 4)

Drill a hole to the required embedment depth.
Drill bit diameter according to Table B1, B2 or B3.
The hollow drilling system removes the dust and cleans the bore hole.
Proceed with Step 3.

Attention! Standing water in the bore hole must be removed before cleaning.

Manual Air Cleaning (MAC)

for bore hole diameter $d_0 \leq 20\text{mm}$ and bore hole depth $h_0 \leq 10d_{\text{nom}}$ (uncracked concrete only)

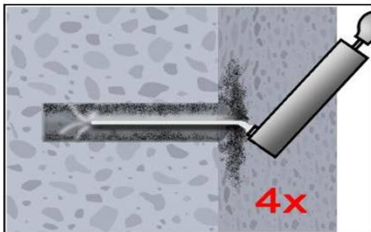

2a. Blow the bore hole clean minimum 4x from the bottom or back by hand pump (Annex B 4).

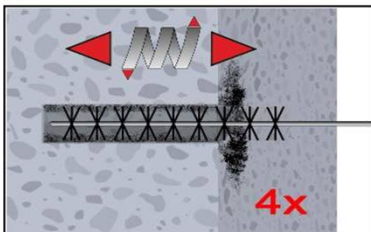

2b. Brush the bore hole minimum 4x with brush RB according to Table B4 over the entire embedment depth in a twisting motion (if necessary, use a brush extension RBL).

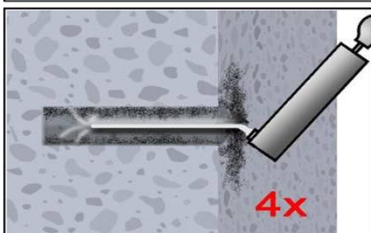

2c. Finally blow the bore hole clean minimum 4x from the bottom or back by hand pump (Annex B 4).

Compressed Air Cleaning (CAC):

All diameter in cracked and uncracked concrete, all drilling methods

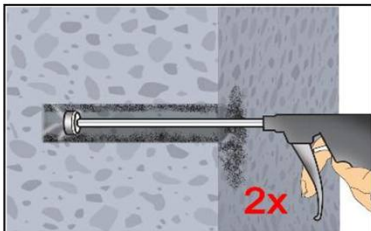

2a. Blow the bore hole clean minimum 2x with compressed air (min. 6 bar) (Annex B 4) over the entire embedment depth until return air stream is free of noticeable dust. (If necessary, an extension shall be used.)

ABS Injection System UM-H for concrete

Intended use
Installation instructions

Annex B 6

Installation instructions (continuation)

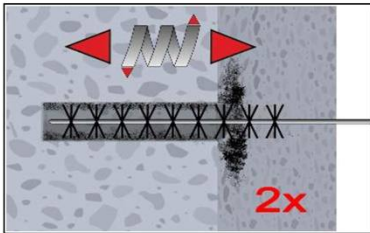

2b. Brush the bore hole minimum 2x with brush RB according to Table B4 over the entire embedment depth in a twisting motion. (If necessary, a brush extension shall be used .RBL)

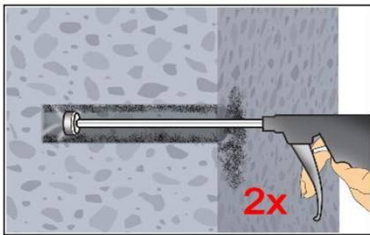

2c. Finally blow the bore hole clean minimum 2x with compressed air (min. 6 bar) (Annex B 4) over the entire embedment depth until return air stream is free of noticeable dust. (If necessary, an extension shall be used.)

Cleaned bore hole has to be protected against re-contamination in an appropriate way, If necessary, repeat cleaning process directly before dispensing the mortar. In-flowing water must not contaminate the bore hole again.

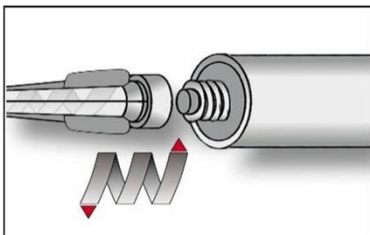

3. Screw on static-mixing nozzle PM-19E and load the cartridge into an appropriate dispensing tool.
For every working interruption longer than the maximum working time t_{work} (Annex B 5) as well as for new cartridges, a new static-mixer shall be used.

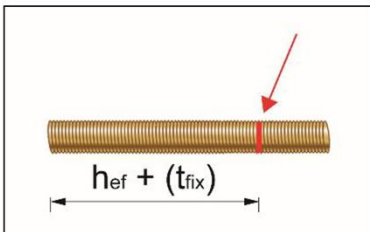

4. Mark embedment depth on the anchor rod. Consider t_{fix} in case of push through installations.
The anchor rod shall be free of dirt, grease, oil or other foreign material.

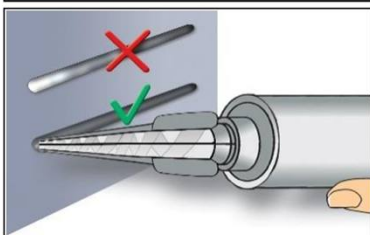

5. Not proper mixed mortar is not sufficient for fastening.
Dispense and discard mortar until an uniform grey colour is shown (at least 3 full strokes).

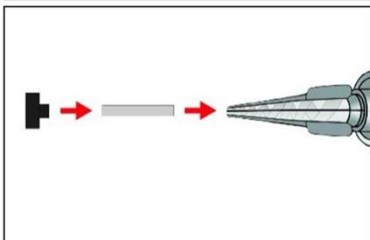

6. Piston plugs VS and mixer nozzle extensions VL shall be used according to Table B4 for the following applications:

- Horizontal and vertical downwards direction: Drill bit- $\varnothing d_0 \geq 18$ mm and embedment depth $h_{ef} > 250$ mm
- Vertical upwards direction: Drill bit- $\varnothing d_0 \geq 18$ mm

Assemble mixing nozzle, mixer extension and piston plug before injecting mortar.

ABS Injection System UM-H for concrete

Intended use
Installation instructions (continuation)

Annex B 7

Installation instructions (continuation)

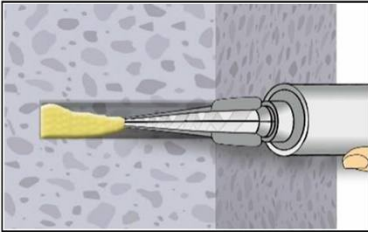

7a. Injecting mortar without piston plug VS
Starting at bottom of the hole and fill the hole up to approximately two-thirds with mortar. (If necessary, a mixer nozzle extension shall be used.) Slowly withdraw of the static mixing nozzle avoid creating air pockets
Observe the temperature related working time t_{work} (Annex B 5).

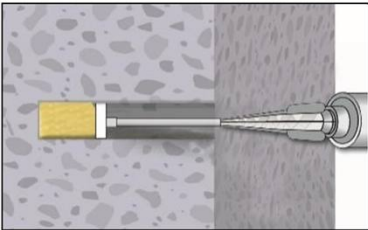

7b. Injecting mortar with piston plug VS
Starting at bottom of the hole and fill the hole up to approximately two-thirds with mortar. (If necessary, a mixer nozzle extension shall be used.) During injection the piston plug is pushed out of the bore hole by the back pressure of the mortar.
Observe the temperature related working time t_{work} (Annex B 5).

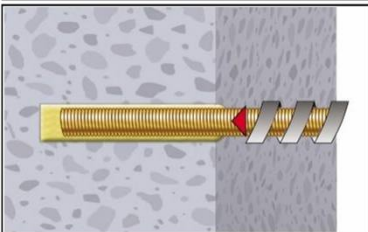

8. Insert the anchor rod while turning slightly up to the embedment mark.

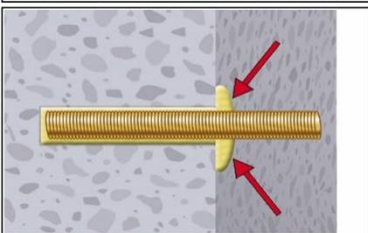

9. Annular gap between anchor rod and base material must be completely filled with mortar. In case of push through installation the annular gap in the fixture must be filled with mortar also.
Otherwise, the installation must be repeated starting from step 7 before the maximum working time t_{work} has expired.

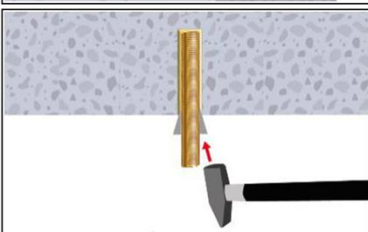

10. For application in vertical upwards direction the anchor rod shall be fixed (e.g. wedges).

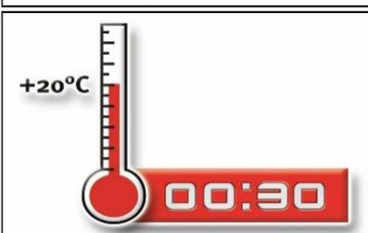

11. Temperature related curing time t_{cure} (Annex B 5) must be observed.
Do not move or load the fastener during curing time.

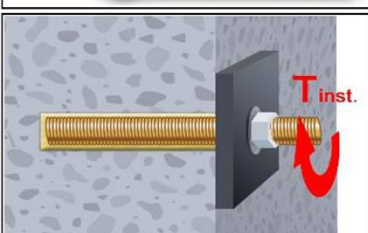

12. Install the fixture by using a calibrated torque wrench. Observe maximum installation torque (Table B1 or B3).
In case of static requirements (e.g. seismic), fill the annular gab in the fixture with mortar (Annex 2). Therefore replace the washer by the filling washer VFS and use the mixer reduction nozzle MR.

ABS Injection System UM-H for concrete

Intended use
Installation instructions (continuation)

Annex B 8

Table C1: Characteristic values for steel tension resistance and steel shear resistance of threaded rods											
Threaded rod			M8	M10	M12	M16	M20	M24	M27	M30	
Cross section area	A_s	[mm ²]	36,6	58	84,3	157	245	353	459	561	
Characteristic tension resistance, Steel failure ¹⁾											
Steel, Property class 4.6 and 4.8	$N_{Rk,s}$	[kN]	15 (13)	23 (21)	34	63	98	141	184	224	
Steel, Property class 5.6 and 5.8	$N_{Rk,s}$	[kN]	18 (17)	29 (27)	42	78	122	176	230	280	
Steel, Property class 8.8	$N_{Rk,s}$	[kN]	29 (27)	46 (43)	67	125	196	282	368	449	
Stainless steel A2, A4 and HCR, class 50	$N_{Rk,s}$	[kN]	18	29	42	79	123	177	230	281	
Stainless steel A2, A4 and HCR, class 70	$N_{Rk,s}$	[kN]	26	41	59	110	171	247	-. ³⁾	-. ³⁾	
Stainless steel A4 and HCR, class 80	$N_{Rk,s}$	[kN]	29	46	67	126	196	282	-. ³⁾	-. ³⁾	
Characteristic tension resistance, Partial factor ²⁾											
Steel, Property class 4.6 and 5.6	$\gamma_{Ms,N}$	[-]	2,0								
Steel, Property class 4.8, 5.8 and 8.8	$\gamma_{Ms,N}$	[-]	1,5								
Stainless steel A2, A4 and HCR, class 50	$\gamma_{Ms,N}$	[-]	2,86								
Stainless steel A2, A4 and HCR, class 70	$\gamma_{Ms,N}$	[-]	1,87								
Stainless steel A4 and HCR, class 80	$\gamma_{Ms,N}$	[-]	1,6								
Characteristic shear resistance, Steel failure ¹⁾											
Without lever arm	Steel, Property class 4.6 and 4.8	$V^0_{Rk,s}$	[kN]	9 (8)	14 (13)	20	38	59	85	110	135
	Steel, Property class 5.6 and 5.8	$V^0_{Rk,s}$	[kN]	11 (10)	17 (16)	25	47	74	106	138	168
	Steel, Property class 8.8	$V^0_{Rk,s}$	[kN]	15 (13)	23 (21)	34	63	98	141	184	224
	Stainless steel A2, A4 and HCR, class 50	$V^0_{Rk,s}$	[kN]	9	15	21	39	61	88	115	140
	Stainless steel A2, A4 and HCR, class 70	$V^0_{Rk,s}$	[kN]	13	20	30	55	86	124	-. ³⁾	-. ³⁾
	Stainless steel A4 and HCR, class 80	$V^0_{Rk,s}$	[kN]	15	23	34	63	98	141	-. ³⁾	-. ³⁾
With lever arm	Steel, Property class 4.6 and 4.8	$M^0_{Rk,s}$	[Nm]	15 (13)	30 (27)	52	133	260	449	666	900
	Steel, Property class 5.6 and 5.8	$M^0_{Rk,s}$	[Nm]	19 (16)	37 (33)	65	166	324	560	833	1123
	Steel, Property class 8.8	$M^0_{Rk,s}$	[Nm]	30 (26)	60 (53)	105	266	519	896	1333	1797
	Stainless steel A2, A4 and HCR, class 50	$M^0_{Rk,s}$	[Nm]	19	37	66	167	325	561	832	1125
	Stainless steel A2, A4 and HCR, class 70	$M^0_{Rk,s}$	[Nm]	26	52	92	232	454	784	-. ³⁾	-. ³⁾
	Stainless steel A4 and HCR, class 80	$M^0_{Rk,s}$	[Nm]	30	59	105	266	519	896	-. ³⁾	-. ³⁾
Characteristic shear resistance, Partial factor ²⁾											
Steel, Property class 4.6 and 5.6	$\gamma_{Ms,V}$	[-]	1,67								
Steel, Property class 4.8, 5.8 and 8.8	$\gamma_{Ms,V}$	[-]	1,25								
Stainless steel A2, A4 and HCR, class 50	$\gamma_{Ms,V}$	[-]	2,38								
Stainless steel A2, A4 and HCR, class 70	$\gamma_{Ms,V}$	[-]	1,56								
Stainless steel A4 and HCR, class 80	$\gamma_{Ms,V}$	[-]	1,33								
¹⁾ Values are only valid for the given stress area A_s . Values in brackets are valid for undersized threaded rods with smaller stress area A_s for hot-dip galvanised threaded rods according to EN ISO 10684:2004+AC:2009. ²⁾ in absence of national regulation ³⁾ Fastener type not part of the ETA											
ABS Injection System UM-H for concrete									Annex C 1		
Performances Characteristic values for steel tension resistance and steel shear resistance of threaded rods											

Table C2: Characteristic values of tension loads under static and quasi-static action for a working life of 50 and 100 years				
Fastener			All Anchor types and sizes	
Concrete cone failure				
Uncracked concrete	$k_{ucr,N}$	[-]	11,0	
Cracked concrete	$k_{cr,N}$	[-]	7,7	
Edge distance	$c_{cr,N}$	[mm]	1,5 h_{ef}	
Axial distance	$s_{cr,N}$	[mm]	2 $c_{cr,N}$	
Splitting				
Edge distance	$h/h_{ef} \geq 2,0$	$c_{cr,sp}$	[mm]	1,0 h_{ef}
	$2,0 > h/h_{ef} > 1,3$			$2 \cdot h_{ef} \left(2,5 - \frac{h}{h_{ef}} \right)$
	$h/h_{ef} \leq 1,3$			2,4 h_{ef}
Axial distance	$s_{cr,sp}$	[mm]	2 $c_{cr,sp}$	
ABS Injection System UM-H for concrete				Annex C 2
Performances Characteristic values of tension loads under static and quasi-static action for a working life of 50 and 100 years				

Table C3: Characteristic values of tension loads under static and quasi-static action for a working life of 50 years												
Threaded rod				M8	M10	M12	M16	M20	M24	M27	M30	
Steel failure												
Characteristic tension resistance		$N_{Rk,s}$	[kN]	$A_s \cdot f_{uk}$ (or see Table C1)								
Partial factor		$\gamma_{Ms,N}$	[-]	see Table C1								
Combined pull-out and concrete failure												
Characteristic bond resistance in uncracked concrete C20/25												
Temperature range	I: 24°C/40°C	Dry, wet concrete and flooded bore hole	$\tau_{Rk,ucr}$	[N/mm ²]	17	17	16	15	14	13	13	13
	II: 50°C/80°C		$\tau_{Rk,ucr}$	[N/mm ²]	17	17	16	15	14	13	13	13
	III: 72°C/120°C		$\tau_{Rk,ucr}$	[N/mm ²]	15	14	14	13	12	12	11	11
	IV: 100°C/160°C		$\tau_{Rk,ucr}$	[N/mm ²]	12	11	11	10	9,5	9,0	9,0	9,0
Characteristic bond resistance in cracked concrete C20/25												
Temperature range	I: 24°C/40°C	Dry, wet concrete and flooded bore hole	$\tau_{Rk,cr}$	[N/mm ²]	7,0	7,5	8,0	9,0	8,5	7,0	7,0	7,0
	II: 50°C/80°C		$\tau_{Rk,cr}$	[N/mm ²]	7,0	7,5	8,0	9,0	8,5	7,0	7,0	7,0
	III: 72°C/120°C		$\tau_{Rk,cr}$	[N/mm ²]	6,0	6,5	7,0	7,5	7,0	6,0	6,0	6,0
	IV: 100°C/160°C		$\tau_{Rk,cr}$	[N/mm ²]	5,5	5,5	6,0	6,5	6,0	5,5	5,5	5,5
Reduktion factor ψ_{sus}^0 in cracked and uncracked concrete C20/25												
Temperature range	I: 24°C/40°C	Dry, wet concrete and flooded bore hole	ψ_{sus}^0	[-]	0,90							
	II: 50°C/80°C				0,87							
	III: 72°C/120°C				0,75							
	IV: 100°C/160°C				0,66							
Increasing factors for concrete		ψ_c	[-]	$(f_{ck} / 20)^{0,1}$								
Characteristic bond resistance depending on the concrete strength class		$\tau_{Rk,ucr} =$		$\psi_c \cdot \tau_{Rk,ucr,(C20/25)}$								
		$\tau_{Rk,cr} =$		$\psi_c \cdot \tau_{Rk,cr,(C20/25)}$								
Concrete cone failure												
Relevant parameter				see Table C2								
Splitting												
Relevant parameter				see Table C2								
Installation factor												
for dry and wet concrete	MAC	γ_{inst}	[-]	1,2					No Performance assessed			
	CAC			1,0								
	HDB			1,2								
for flooded bore hole	CAC	1,4										
ABS Injection System UM-H for concrete										Annex C 3		
Performances Characteristic values of tension loads under static and quasi-static action for a working life of 50 years (threaded rod)												

Table C4: Characteristic values of tension loads under static and quasi-static action for a working life of 100 years												
Threaded rod					M8	M10	M12	M16	M20	M24	M27	M30
Steel failure												
Characteristic tension resistance			$N_{Rk,s}$	[kN]	$A_s \cdot f_{uk}$ (or see Table C1)							
Partial factor			$\gamma_{Ms,N}$	[-]	see Table C1							
Combined pull-out and concrete failure												
Characteristic bond resistance in uncracked concrete C20/25												
Temperature range	I: 24°C/40°C	Dry, wet concrete and flooded bore hole	$\tau_{Rk,ucr,100}$	[N/mm ²]	17	17	16	15	14	13	13	13
	II: 50°C/80°C		$\tau_{Rk,ucr,100}$	[N/mm ²]	17	17	16	15	14	13	13	13
Characteristic bond resistance in cracked concrete C20/25												
Temperature range	I: 24°C/40°C	Dry, wet concrete and flooded bore hole	$\tau_{Rk,cr,100}$	[N/mm ²]	5,5	6,0	6,5	6,5	6,5	6,5	6,5	6,5
	II: 50°C/80°C		$\tau_{Rk,cr,100}$	[N/mm ²]	5,5	6,0	6,5	6,5	6,5	6,5	6,5	6,5
Reduktion factor $\psi^0_{sus,100}$ in cracked and uncracked concrete C20/25												
Temperature range	I: 24°C/40°C	Dry, wet concrete and flooded bore hole	$\psi^0_{sus,100}$	[-]	0,90							
	II: 50°C/80°C				0,87							
Increasing factors for concrete			ψ_c	[-]	$(f_{ck} / 20)^{0,1}$							
Characteristic bond resistance depending on the concrete strength class			$\tau_{Rk,ucr,100} =$		$\psi_c \cdot \tau_{Rk,ucr,100,(C20/25)}$							
			$\tau_{Rk,cr,100} =$		$\psi_c \cdot \tau_{Rk,cr,100,(C20/25)}$							
Concrete cone failure												
Relevant parameter					see Table C2							
Splitting												
Relevant parameter					see Table C2							
Installation factor												
for dry and wet concrete	MAC	γ_{inst}	[-]	1,2					No Performance assessed			
	CAC			1,0								
	HDB			1,2								
for flooded bore hole	CAC	1,4										
ABS Injection System UM-H for concrete										Annex C 4		
Performances Characteristic values of tension loads under static and quasi-static action for a working life of 100 years (threaded rod)												

Table C6: Characteristic values of tension loads under static and quasi-static action for a working life of 50 years										
Internal threaded anchor rods				IG-M6	IG-M8	IG-M10	IG-M12	IG-M16	IG-M20	
Steel failure¹⁾										
Characteristic tension resistance, Steel, strength class	5.8 8.8	$N_{Rk,s}$	[kN]	10	17	29	42	76	123	
Partial factor, strength class 5.8 and 8.8		$\gamma_{Ms,N}$	[-]	1,5						
Characteristic tension resistance, Stainless Steel A4 and HCR, Strength class 70 ²⁾		$N_{Rk,s}$	[kN]	14	26	41	59	110	124	
Partial factor		$\gamma_{Ms,N}$	[-]	1,87						
Combined pull-out and concrete cone failure										
Characteristic bond resistance in uncracked concrete C20/25										
Temperature range	I: 24°C/40°C	Dry, wet concrete and flooded bore hole	$\tau_{Rk,ucr}$	[N/mm ²]	17	16	15	14	13	13
	II: 50°C/80°C		$\tau_{Rk,ucr}$	[N/mm ²]	17	16	15	14	13	13
	III: 72°C/120°C		$\tau_{Rk,ucr}$	[N/mm ²]	14	14	13	12	12	11
	IV: 100°C/160°C		$\tau_{Rk,ucr}$	[N/mm ²]	11	11	10	9,5	9,0	9,0
Characteristic bond resistance in cracked concrete C20/25										
Temperature range	I: 24°C/40°C	Dry, wet concrete and flooded bore hole	$\tau_{Rk,cr}$	[N/mm ²]	7,5	8,0	9,0	8,5	7,0	7,0
	II: 50°C/80°C		$\tau_{Rk,cr}$	[N/mm ²]	7,5	8,0	9,0	8,5	7,0	7,0
	III: 72°C/120°C		$\tau_{Rk,cr}$	[N/mm ²]	6,5	7,0	7,5	7,0	6,0	6,0
	IV: 100°C/160°C		$\tau_{Rk,cr}$	[N/mm ²]	5,5	6,0	6,5	6,0	5,5	5,5
Reduktion factor ψ_{sus}^0 in cracked and uncracked concrete C20/25										
Temperature range	I: 24°C/40°C	Dry, wet concrete and flooded bore hole	ψ_{sus}^0	[-]	0,90					
	II: 50°C/80°C				0,87					
	III: 72°C/120°C				0,75					
	IV: 100°C/160°C				0,66					
Increasing factors for concrete			ψ_c	[-]	$(f_{ck} / 20)^{0,1}$					
Characteristic bond resistance depending on the concrete strength class			$\tau_{Rk,ucr} =$		$\psi_c \cdot \tau_{Rk,ucr,(C20/25)}$					
			$\tau_{Rk,cr} =$		$\psi_c \cdot \tau_{Rk,cr,(C20/25)}$					
Concrete cone failure										
Relevant parameter				see Table C2						
Splitting failure										
Relevant parameter				see Table C2						
Installation factor										
for dry and wet concrete	MAC	γ_{inst}	[-]	1,2			No Performance assessed			
	CAC			1,0						
	HDB			1,2						
for flooded bore hole	CAC			1,4						
¹⁾ Fastenings (incl. nut and washer) must comply with the appropriate material and property class of the internal threaded rod. The characteristic tension resistance for steel failure is valid for the internal threaded rod and the fastening element. ²⁾ For IG-M20 strength class 50 is valid										
ABS Injection System UM-H for concrete								Annex C 6		
Performances Characteristic values of tension loads under static and quasi-static action for a working life of 50 years (internal threaded anchor rod)										

Table C7: Characteristic values of tension loads under static and quasi-static action for a working life of 100 years										
Internal threaded anchor rods				IG-M6	IG-M8	IG-M10	IG-M12	IG-M16	IG-M20	
Steel failure¹⁾										
Characteristic tension resistance, Steel, strength class	5.8	$N_{Rk,s}$	[kN]	10	17	29	42	76	123	
	8.8	$N_{Rk,s}$	[kN]	16	27	46	67	121	196	
Partial factor, strength class 5.8 and 8.8	$\gamma_{Ms,N}$		[-]	1,5						
Characteristic tension resistance, Stainless Steel A4 and HCR, Strength class 70 ²⁾		$N_{Rk,s}$	[kN]	14	26	41	59	110	124	
Partial factor	$\gamma_{Ms,N}$		[-]	1,87						
Combined pull-out and concrete cone failure										
Characteristic bond resistance in uncracked concrete C20/25										
Temperature range	I: 24°C/40°C	Dry, wet concrete and flooded bore hole	$\tau_{Rk,ucr,100}$	[N/mm ²]	17	16	15	14	13	13
	II: 50°C/80°C		$\tau_{Rk,ucr,100}$	[N/mm ²]	17	16	15	14	13	13
Characteristic bond resistance in cracked concrete C20/25										
Temperature range	I: 24°C/40°C	Dry, wet concrete and flooded bore hole	$\tau_{Rk,cr,100}$	[N/mm ²]	6,0	6,5	6,5	6,5	6,5	6,5
	II: 50°C/80°C		$\tau_{Rk,cr,100}$	[N/mm ²]	6,0	6,5	6,5	6,5	6,5	6,5
Reduktion factor $\psi^0_{sus,100}$ in cracked and uncracked concrete C20/25										
Temperature range	I: 24°C/40°C	Dry, wet concrete and flooded bore hole	$\psi^0_{sus,100}$	[-]	0,90					
	II: 50°C/80°C				0,87					
Increasing factors for concrete			ψ_c	[-]	$(f_{ck} / 20)^{0,1}$					
Characteristic bond resistance depending on the concrete strength class			$\tau_{Rk,ucr,100} =$		$\psi_c \cdot \tau_{Rk,ucr,100,(C20/25)}$					
			$\tau_{Rk,cr,100} =$		$\psi_c \cdot \tau_{Rk,cr,100,(C20/25)}$					
Concrete cone failure										
Relevant parameter				see Table C2						
Splitting failure										
Relevant parameter				see Table C2						
Installation factor										
for dry and wet concrete	MAC	γ_{inst}	[-]	1,2			No Performance assessed			
	CAC			1,0						
	HDB			1,2						
for flooded bore hole	CAC			1,4						
¹⁾ Fastenings (incl. nut and washer) must comply with the appropriate material and property class of the internal threaded rod. The characteristic tension resistance for steel failure is valid for the internal threaded rod and the fastening element. ²⁾ For IG-M20 strength class 50 is valid										
ABS Injection System UM-H for concrete								Annex C 7		
Performances Characteristic values of tension loads under static and quasi-static action for a working life of 100 years (internal threaded anchor rod)										

Table C8: Characteristic values of shear loads under static and quasi-static action for a working life of 50 and 100 years									
Internal threaded anchor rods				IG-M6	IG-M8	IG-M10	IG-M12	IG-M16	IG-M20
Steel failure without lever arm¹⁾									
Characteristic shear resistance, Steel, strength class	5.8	$V_{Rk,s}^0$	[kN]	5	9	15	21	38	61
	8.8	$V_{Rk,s}^0$	[kN]	8	14	23	34	60	98
Partial factor, strength class 5.8 and 8.8		$\gamma_{Ms,V}$	[-]	1,25					
Characteristic shear resistance, Stainless Steel A4 and HCR, Strength class 70 ²⁾		$V_{Rk,s}^0$	[kN]	7	13	20	30	55	40
		$\gamma_{Ms,V}$	[-]	1,56					2,38
Ductility factor		k_7	[-]	1,0					
Steel failure with lever arm¹⁾									
Characteristic bending moment, Steel, strength class	5.8	$M_{Rk,s}^0$	[Nm]	8	19	37	66	167	325
	8.8	$M_{Rk,s}^0$	[Nm]	12	30	60	105	267	519
Partial factor, strength class 5.8 and 8.8		$\gamma_{Ms,V}$	[-]	1,25					
Characteristic bending moment, Stainless Steel A4 and HCR, Strength class 70 ²⁾		$M_{Rk,s}^0$	[Nm]	11	26	52	92	233	456
		$\gamma_{Ms,V}$	[-]	1,56					2,38
Concrete pry-out failure									
Factor		k_8	[-]	2,0					
Installation factor		γ_{inst}	[-]	1,0					
Concrete edge failure									
Effective length of fastener		l_f	[mm]	$\min(h_{ef}; 12 \cdot d_{nom})$					$\min(h_{ef}; 300\text{mm})$
Outside diameter of fastener		d_{nom}	[mm]	10	12	16	20	24	30
Installation factor		γ_{inst}	[-]	1,0					
<p>1) Fastenings (incl. nut and washer) must comply with the appropriate material and property class of the internal threaded rod. The characteristic tension resistance for steel failure is valid for the internal threaded rod and the fastening element.</p> <p>2) For IG-M20 strength class 50 is valid</p>									
ABS Injection System UM-H for concrete								Annex C 8	
Performances Characteristic values of shear loads under static and quasi-static action for a working life of 50 and 100 years (internal threaded anchor rod)									

Table C9: Characteristic values of tension loads under static and quasi-static action for a working life of 50 years													
Reinforcing bar			Ø 8	Ø 10	Ø 12	Ø 14	Ø 16	Ø 20	Ø 24	Ø 25	Ø 28	Ø 32	
Steel failure													
Characteristic tension resistance	$N_{Rk,s}$	[kN]	$A_s \cdot f_{uk}^{1)}$										
Cross section area	A_s	[mm ²]	50	79	113	154	201	314	452	491	616	804	
Partial factor	$\gamma_{Ms,N}$	[-]	1,4 ²⁾										
Combined pull-out and concrete failure													
Characteristic bond resistance in uncracked concrete C20/25													
Temperature range	I: 24°C/40°C	Dry, wet concrete and flooded bore hole	$\tau_{Rk,ucr}$	[N/mm ²]	14	14	14	14	13	13	13	13	13
	II: 50°C/80°C		$\tau_{Rk,ucr}$	[N/mm ²]	14	14	14	14	13	13	13	13	13
	III: 72°C/120°C		$\tau_{Rk,ucr}$	[N/mm ²]	13	12	12	12	12	11	11	11	11
	IV: 100°C/160°C		$\tau_{Rk,ucr}$	[N/mm ²]	9,5	9,5	9,5	9,0	9,0	9,0	9,0	8,5	8,5
Characteristic bond resistance in cracked concrete C20/25													
Temperature range	I: 24°C/40°C	Dry, wet concrete and flooded bore hole	$\tau_{Rk,cr}$	[N/mm ²]	5,5	5,5	6,0	6,5	6,5	6,5	6,5	7,0	7,0
	II: 50°C/80°C		$\tau_{Rk,cr}$	[N/mm ²]	5,5	5,5	6,0	6,5	6,5	6,5	6,5	7,0	7,0
	III: 72°C/120°C		$\tau_{Rk,cr}$	[N/mm ²]	4,5	5,0	5,0	5,5	5,5	5,5	5,5	6,0	6,0
	IV: 100°C/160°C		$\tau_{Rk,cr}$	[N/mm ²]	4,0	4,5	4,5	5,0	5,0	5,0	5,0	5,0	5,0
Reduktion factor ψ_{sus}^0 in cracked and uncracked concrete C20/25													
Temperature range	I: 24°C/40°C	Dry, wet concrete and flooded bore hole	ψ_{sus}^0	[-]	0,90								
	II: 50°C/80°C				0,87								
	III: 72°C/120°C				0,75								
	IV: 100°C/160°C				0,66								
Increasing factors for concrete			ψ_c	[-]	$(f_{ck} / 20)^{0,1}$								
Characteristic bond resistance depending on the concrete strength class			$\tau_{Rk,ucr} =$		$\psi_c \cdot \tau_{Rk,ucr,(C20/25)}$								
			$\tau_{Rk,cr} =$		$\psi_c \cdot \tau_{Rk,cr,(C20/25)}$								
Concrete cone failure													
Relevant parameter			see Table C2										
Splitting													
Relevant parameter			see Table C2										
Installation factor													
for dry and wet concrete	MAC	γ_{inst}	[-]	1,2					No Performance assessed				
	CAC			1,0									
	HDB			1,2									
for flooded bore hole	CAC	1,4											
¹⁾ f_{uk} shall be taken from the specifications of reinforcing bars ²⁾ in absence of national regulation													
ABS Injection System UM-H for concrete											Annex C 9		
Performances Characteristic values of tension loads under static and quasi-static action for a working life of 50 years (rebar)													

Table C10: Characteristic values of tension loads under static and quasi-static action for a working life of 100 years													
Reinforcing bar			Ø 8	Ø 10	Ø 12	Ø 14	Ø 16	Ø 20	Ø 24	Ø 25	Ø 28	Ø 32	
Steel failure													
Characteristic tension resistance		$N_{Rk,s}$	[kN]	$A_s \cdot f_{uk}^{1)}$									
Cross section area		A_s	[mm ²]	50	79	113	154	201	314	452	491	616	804
Partial factor		$\gamma_{Ms,N}$	[-]	1,4 ²⁾									
Combined pull-out and concrete failure													
Characteristic bond resistance in uncracked concrete C20/25													
Temperature range	I: 24°C/40°C	Dry, wet concrete and flooded bore hole	$\tau_{Rk,ucr,100}$	[N/mm ²]	14	14	14	14	13	13	13	13	13
	II: 50°C/80°C		$\tau_{Rk,ucr,100}$	[N/mm ²]	14	14	14	14	13	13	13	13	13
Characteristic bond resistance in cracked concrete C20/25													
Temperature range	I: 24°C/40°C	Dry, wet concrete and flooded bore hole	$\tau_{Rk,cr,100}$	[N/mm ²]	4,5	4,5	4,5	4,5	4,5	4,0	4,0	4,0	4,0
	II: 50°C/80°C		$\tau_{Rk,cr,100}$	[N/mm ²]	4,5	4,5	4,5	4,5	4,5	4,0	4,0	4,0	4,0
Reduktion factor $\psi_{sus,100}^0$ in cracked and uncracked concrete C20/25													
Temperature range	I: 24°C/40°C	Dry, wet concrete and flooded bore hole	$\psi_{sus,100}^0$	[-]	0,90								
	II: 50°C/80°C				0,87								
Increasing factors for concrete		ψ_c	[-]	$(f_{ck} / 20)^{0,1}$									
Characteristic bond resistance depending on the concrete strength class		$\tau_{Rk,ucr,100} =$		$\psi_c \cdot \tau_{Rk,ucr,100,(C20/25)}$									
		$\tau_{Rk,cr,100} =$		$\psi_c \cdot \tau_{Rk,cr,100,(C20/25)}$									
Concrete cone failure													
Relevant parameter			see Table C2										
Splitting													
Relevant parameter			see Table C2										
Installation factor													
for dry and wet concrete	MAC	γ_{inst}	[-]	1,2					No Performance assessed				
	CAC			1,0									
	HDB			1,2									
for flooded bore hole	CAC			1,4									
¹⁾ f_{uk} shall be taken from the specifications of reinforcing bars ²⁾ in absence of national regulation													
ABS Injection System UM-H for concrete											Annex C 10		
Performances Characteristic values of tension loads under static and quasi-static action for a working life of 100 years (rebar)													

Table C11: Characteristic values of shear loads under static and quasi-static action for a working life of 50 and 100 years														
Reinforcing bar			Ø 8	Ø 10	Ø 12	Ø 14	Ø 16	Ø 20	Ø 24	Ø 25	Ø 28	Ø 32		
Steel failure without lever arm														
Characteristic shear resistance	$V_{Rk,s}^0$	[kN]	$0,50 \cdot A_s \cdot f_{uk}^{1)}$											
Cross section area	A_s	[mm ²]	50	79	113	154	201	314	452	491	616	804		
Partial factor	$\gamma_{Ms,V}$	[-]	1,5 ²⁾											
Ductility factor	k_7	[-]	1,0											
Steel failure with lever arm														
Characteristic bending moment	$M_{Rk,s}^0$	[Nm]	$1.2 \cdot W_{el} \cdot f_{uk}^{1)}$											
Elastic section modulus	W_{el}	[mm ³]	50	98	170	269	402	785	1357	1534	2155	3217		
Partial factor	$\gamma_{Ms,V}$	[-]	1,5 ²⁾											
Concrete pry-out failure														
Factor	k_8	[-]	2,0											
Installation factor	γ_{inst}	[-]	1,0											
Concrete edge failure														
Effective length of fastener	l_f	[mm]	$\min(h_{ef}; 12 \cdot d_{nom})$							$\min(h_{ef}; 300\text{mm})$				
Outside diameter of fastener	d_{nom}	[mm]	8	10	12	14	16	20	24	25	28	32		
Installation factor	γ_{inst}	[-]	1,0											
<p>1) f_{uk} shall be taken from the specifications of reinforcing bars</p> <p>2) in absence of national regulation</p>														
ABS Injection System UM-H for concrete										Annex C 11				
Performances Characteristic values of shear loads under static and quasi-static action for a working life of 50 and 100 years (rebar)														

Table C12: Displacements under tension load¹⁾

Threaded rod		M8	M10	M12	M16	M20	M24	M27	M30	
Uncracked concrete C20/25 under static and quasi-static action for a working life of 50 and 100 years										
Temperature range I: 24°C/40°C II: 50°C/80°C	δ_{N0} -factor	[mm/(N/mm ²)]	0,031	0,032	0,034	0,037	0,039	0,042	0,044	0,046
	$\delta_{N\infty}$ -factor	[mm/(N/mm ²)]	0,040	0,042	0,044	0,047	0,051	0,054	0,057	0,060
Temperature range III: 72°C/120°C	δ_{N0} -factor	[mm/(N/mm ²)]	0,032	0,034	0,035	0,038	0,041	0,044	0,046	0,048
	$\delta_{N\infty}$ -factor	[mm/(N/mm ²)]	0,042	0,044	0,045	0,049	0,053	0,056	0,059	0,062
Temperature range IV: 100°C/160°C	δ_{N0} -factor	[mm/(N/mm ²)]	0,121	0,126	0,131	0,142	0,153	0,163	0,171	0,179
	$\delta_{N\infty}$ -factor	[mm/(N/mm ²)]	0,124	0,129	0,135	0,146	0,157	0,168	0,176	0,184
Cracked concrete under static and quasi-static action for a working life of 50 and 100 years										
Temperature range I: 24°C/40°C II: 50°C/80°C	δ_{N0} -factor	[mm/(N/mm ²)]	0,081	0,083	0,085	0,090	0,095	0,099	0,103	0,106
	$\delta_{N\infty}$ -factor	[mm/(N/mm ²)]	0,104	0,107	0,110	0,116	0,122	0,128	0,133	0,137
Temperature range III: 72°C/120°C	δ_{N0} -factor	[mm/(N/mm ²)]	0,084	0,086	0,088	0,093	0,098	0,103	0,107	0,110
	$\delta_{N\infty}$ -factor	[mm/(N/mm ²)]	0,108	0,111	0,114	0,121	0,127	0,133	0,138	0,143
Temperature range IV: 100°C/160°C	δ_{N0} -factor	[mm/(N/mm ²)]	0,312	0,321	0,330	0,349	0,367	0,385	0,399	0,412
	$\delta_{N\infty}$ -factor	[mm/(N/mm ²)]	0,321	0,330	0,340	0,358	0,377	0,396	0,410	0,424

1) Calculation of the displacement

$$\delta_{N0} = \delta_{N0}\text{-factor} \cdot \tau; \quad \tau: \text{action bond stress for tension}$$

$$\delta_{N\infty} = \delta_{N\infty}\text{-factor} \cdot \tau;$$

Table C13: Displacements under shear load¹⁾

Threaded rod		M8	M10	M12	M16	M20	M24	M27	M30	
Uncracked and cracked concrete under static and quasi-static action for a working life of 50 and 100 years										
All temperature ranges	δ_{V0} -factor	[mm/kN]	0,06	0,06	0,05	0,04	0,04	0,03	0,03	0,03
	$\delta_{V\infty}$ -factor	[mm/kN]	0,09	0,08	0,08	0,06	0,06	0,05	0,05	0,05

1) Calculation of the displacement

$$\delta_{V0} = \delta_{V0}\text{-factor} \cdot V; \quad V: \text{action shear load}$$

$$\delta_{V\infty} = \delta_{V\infty}\text{-factor} \cdot V;$$

ABS Injection System UM-H for concrete

Performances

Displacements under static and quasi-static action
for a working life of 50 and 100 years (threaded rod)

Annex C 12

Table C14: Displacements under tension load¹⁾								
Internal threaded anchor rods			IG-M6	IG-M8	IG-M10	IG-M12	IG-M16	IG-M20
Uncracked concrete under static and quasi-static action for a working life of 50 and 100 years								
Temperature range I: 24°C/40°C II: 50°C/80°C	δ_{N0} -factor	[mm/(N/mm ²)]	0,032	0,034	0,037	0,039	0,042	0,046
	$\delta_{N\infty}$ -factor	[mm/(N/mm ²)]	0,042	0,044	0,047	0,051	0,054	0,060
Temperature range III: 72°C/120°C	δ_{N0} -factor	[mm/(N/mm ²)]	0,034	0,035	0,038	0,041	0,044	0,048
	$\delta_{N\infty}$ -factor	[mm/(N/mm ²)]	0,044	0,045	0,049	0,053	0,056	0,062
Temperature range IV: 100°C/160°C	δ_{N0} -factor	[mm/(N/mm ²)]	0,126	0,131	0,142	0,153	0,163	0,179
	$\delta_{N\infty}$ -factor	[mm/(N/mm ²)]	0,129	0,135	0,146	0,157	0,168	0,184
Cracked concrete under static and quasi-static action for a working life of 50 and 100 years								
Temperature range I: 24°C/40°C II: 50°C/80°C	δ_{N0} -factor	[mm/(N/mm ²)]	0,083	0,085	0,090	0,095	0,099	0,106
	$\delta_{N\infty}$ -factor	[mm/(N/mm ²)]	0,170	0,110	0,116	0,122	0,128	0,137
Temperature range III: 72°C/120°C	δ_{N0} -factor	[mm/(N/mm ²)]	0,086	0,088	0,093	0,098	0,103	0,110
	$\delta_{N\infty}$ -factor	[mm/(N/mm ²)]	0,111	0,114	0,121	0,127	0,133	0,143
Temperature range IV: 100°C/160°C	δ_{N0} -factor	[mm/(N/mm ²)]	0,321	0,330	0,349	0,367	0,385	0,412
	$\delta_{N\infty}$ -factor	[mm/(N/mm ²)]	0,330	0,340	0,358	0,377	0,396	0,424
¹⁾ Calculation of the displacement $\delta_{N0} = \delta_{N0}\text{-factor} \cdot \tau$; τ : action bond stress for tension $\delta_{N\infty} = \delta_{N\infty}\text{-factor} \cdot \tau$;								
Table C15: Displacements under shear load¹⁾								
Internal threaded anchor rods			IG-M6	IG-M8	IG-M10	IG-M12	IG-M16	IG-M20
Uncracked and cracked concrete under static and quasi-static action for a working life of 50 and 100 years								
All temperature ranges	δ_{V0} -factor	[mm/kN]	0,07	0,06	0,06	0,05	0,04	0,04
	$\delta_{V\infty}$ -factor	[mm/kN]	0,10	0,09	0,08	0,08	0,06	0,06
¹⁾ Calculation of the displacement $\delta_{V0} = \delta_{V0}\text{-factor} \cdot V$; V : action shear load $\delta_{V\infty} = \delta_{V\infty}\text{-factor} \cdot V$;								
ABS Injection System UM-H for concrete							Annex C 13	
Performances Displacements under static and quasi-static action for a working life of 50 and 100 years (internal threaded anchor rod)								

Table C16: Displacements under tension load¹⁾												
Reinforcing bar			Ø 8	Ø 10	Ø 12	Ø 14	Ø 16	Ø 20	Ø 24	Ø 25	Ø 28	Ø 32
Uncracked concrete under static and quasi-static action for a working life of 50 and 100 years												
Temperature range I: 24°C/40°C II: 50°C/80°C	δ_{N0} -factor	[mm/(N/mm ²)]	0,031	0,032	0,034	0,035	0,037	0,039	0,042	0,043	0,045	0,048
	$\delta_{N\infty}$ -factor	[mm/(N/mm ²)]	0,040	0,042	0,044	0,045	0,047	0,051	0,054	0,055	0,058	0,063
Temperature range III: 72°C/120°C	δ_{N0} -factor	[mm/(N/mm ²)]	0,032	0,034	0,035	0,036	0,038	0,041	0,044	0,045	0,047	0,050
	$\delta_{N\infty}$ -factor	[mm/(N/mm ²)]	0,042	0,044	0,045	0,047	0,049	0,053	0,056	0,057	0,060	0,065
Temperature range IV: 100°C/160°C	δ_{N0} -factor	[mm/(N/mm ²)]	0,121	0,126	0,131	0,137	0,142	0,153	0,163	0,164	0,172	0,186
	$\delta_{N\infty}$ -factor	[mm/(N/mm ²)]	0,124	0,129	0,135	0,141	0,146	0,157	0,168	0,169	0,177	0,192
Cracked concrete under static and quasi-static action for a working life of 50 and 100 years												
Temperature range I: 24°C/40°C II: 50°C/80°C	δ_{N0} -factor	[mm/(N/mm ²)]	0,081	0,083	0,085	0,087	0,090	0,095	0,099	0,099	0,103	0,108
	$\delta_{N\infty}$ -factor	[mm/(N/mm ²)]	0,104	0,107	0,110	0,113	0,116	0,122	0,128	0,128	0,133	0,141
Temperature range III: 72°C/120°C	δ_{N0} -factor	[mm/(N/mm ²)]	0,084	0,086	0,088	0,090	0,093	0,098	0,103	0,103	0,107	0,113
	$\delta_{N\infty}$ -factor	[mm/(N/mm ²)]	0,108	0,111	0,114	0,118	0,121	0,127	0,133	0,133	0,138	0,148
Temperature range IV: 100°C/160°C	δ_{N0} -factor	[mm/(N/mm ²)]	0,312	0,321	0,330	0,340	0,349	0,367	0,385	0,385	0,399	0,425
	$\delta_{N\infty}$ -factor	[mm/(N/mm ²)]	0,321	0,330	0,340	0,349	0,358	0,377	0,396	0,396	0,410	0,449
¹⁾ Calculation of the displacement $\delta_{N0} = \delta_{N0}\text{-factor} \cdot \tau$; τ : action bond stress for tension $\delta_{N\infty} = \delta_{N\infty}\text{-factor} \cdot \tau$;												
Table C17: Displacements under shear load¹⁾												
Reinforcing bar			Ø 8	Ø 10	Ø 12	Ø 14	Ø 16	Ø 20	Ø 24	Ø 25	Ø 28	Ø 32
Uncracked and cracked concrete under static and quasi-static action for a working life of 50 and 100 years												
All temperature ranges	δ_{V0} -factor	[mm/kN]	0,06	0,05	0,05	0,04	0,04	0,04	0,03	0,03	0,03	0,03
	$\delta_{V\infty}$ -factor	[mm/kN]	0,09	0,08	0,08	0,06	0,06	0,05	0,05	0,05	0,04	0,04
¹⁾ Calculation of the displacement $\delta_{V0} = \delta_{V0}\text{-factor} \cdot V$; V : action shear load $\delta_{V\infty} = \delta_{V\infty}\text{-factor} \cdot V$;												
ABS Injection System UM-H for concrete										Annex C 14		
Performances Displacements under static and quasi-static action for a working life of 50 and 100 years (rebar)												

Table C18: Characteristic values of tension loads under seismic action (performance category C1) for a working life of 50 years												
Threaded rod				M8	M10	M12	M16	M20	M24	M27	M30	
Steel failure												
Characteristic tension resistance		$N_{Rk,s,eq,C1}$	[kN]	$1,0 \cdot N_{Rk,s}$								
Partial factor		$\gamma_{Ms,N}$	[-]	see Table C1								
Combined pull-out and concrete failure												
Characteristic bond resistance in cracked and uncracked concrete C20/25												
Temperature range	I: 24°C/40°C	Dry, wet concrete and flooded bore hole	$\tau_{Rk,eq,C1}$	[N/mm ²]	7,0	7,5	8,0	9,0	8,5	7,0	7,0	7,0
	II: 50°C/80°C		$\tau_{Rk,eq,C1}$	[N/mm ²]	7,0	7,5	8,0	9,0	8,5	7,0	7,0	7,0
	III: 72°C/120°C		$\tau_{Rk,eq,C1}$	[N/mm ²]	6,0	6,5	7,0	7,5	7,0	6,0	6,0	6,0
	IV: 100°C/160°C		$\tau_{Rk,eq,C1}$	[N/mm ²]	5,5	5,5	6,0	6,5	6,0	5,5	5,5	5,5
Increasing factors for concrete		ψ_c	[-]	1,0								
Characteristic bond resistance depending on the concrete strength class		$\tau_{Rk,eq,C1} =$		$\psi_c \cdot \tau_{Rk,eq,C1,(C20/25)}$								
Installation factor												
for dry and wet concrete	CAC	γ_{inst}	[-]	1,0								
	HDB			1,2								
for flooded bore hole	CAC			1,4								
ABS Injection System UM-H for concrete										Annex C 15		
Performances Characteristic values of tension loads under seismic action (performance category C1) for a working life of 50 years (threaded rod)												

Table C19: Characteristic values of tension loads under seismic action (performance category C1) for a working life of 100 years												
Threaded rod				M8	M10	M12	M16	M20	M24	M27	M30	
Steel failure												
Characteristic tension resistance		$N_{Rk,s,eq,C1}$	[kN]	$1,0 \cdot N_{Rk,s}$								
Partial factor		$\gamma_{Ms,N}$	[-]	see Table C1								
Combined pull-out and concrete failure												
Characteristic bond resistance in cracked and uncracked concrete C20/25												
Temperature range	I: 24°C/40°C	Dry, wet concrete and flooded bore hole	$\tau_{Rk,eq,C1}$	[N/mm ²]	5,5	6	6,5	6,5	6,5	6,5	6,5	6,5
	II: 50°C/80°C		$\tau_{Rk,eq,C1}$	[N/mm ²]	5,5	6	6,5	6,5	6,5	6,5	6,5	6,5
Increasing factors for concrete		ψ_c	[-]	1,0								
Characteristic bond resistance depending on the concrete strength class		$\tau_{Rk,eq,C1} =$		$\psi_c \cdot \tau_{Rk,eq,C1,(C20/25)}$								
Installation factor												
for dry and wet concrete	CAC	γ_{inst}	[-]	1,0								
	HDB			1,2								
for flooded bore hole	CAC			1,4								
ABS Injection System UM-H for concrete										Annex C 16		
Performances Characteristic values of tension loads under seismic action (performance category C1) for a working life of 100 years (threaded rod)												

Table C20: Characteristic values of shear loads under seismic action (performance category C1) for a working life of 50 and 100 years										
Threaded rod			M8	M10	M12	M16	M20	M24	M27	M30
Steel failure										
Characteristic shear resistance (Seismic C1)	$V_{Rk,s,eq,C1}$	[kN]	$0,70 \cdot V_{Rk,s}^0$							
Partial factor	$\gamma_{Ms,V}$	[-]	see Table C1							
Factor for annular gap	α_{gap}	[-]	$0,5 (1,0)^1$							
<p>¹⁾ Value in brackets valid for filled annular gap between fastener and clearance hole in the fixture. Use of special filling washer Annex A 3 is recommended</p>										
ABS Injection System UM-H for concrete									Annex C 17	
Performances Characteristic values of shear loads under seismic action (performance category C1) (threaded rod)										

Table C21: Characteristic values of tension loads under seismic action (performance category C1) for a working life of 50 years														
Reinforcing bar			Ø 8	Ø 10	Ø 12	Ø 14	Ø 16	Ø 20	Ø 24	Ø 25	Ø 28	Ø 32		
Steel failure														
Characteristic tension resistance	$N_{Rk,s,eq,C1}$	[kN]	$1,0 \cdot A_s \cdot f_{uk}^{1)}$											
Cross section area	A_s	[mm ²]	50	79	113	154	201	314	452	491	616	804		
Partial factor	$\gamma_{Ms,N}$	[-]	1,4 ²⁾											
Combined pull-out and concrete failure														
Characteristic bond resistance in cracked and uncracked concrete C20/25														
Temperature range	I: 24°C/40°C	Dry, wet concrete and flooded bore hole	$\tau_{Rk,eq,C1}$	[N/mm ²]	5,5	5,5	6,0	6,5	6,5	6,5	6,5	7,0	7,0	7,0
	II: 50°C/80°C		$\tau_{Rk,eq,C1}$	[N/mm ²]	5,5	5,5	6,0	6,5	6,5	6,5	6,5	7,0	7,0	7,0
	III: 72°C/120°C		$\tau_{Rk,eq,C1}$	[N/mm ²]	4,5	5,0	5,0	5,5	5,5	5,5	5,5	6,0	6,0	6,0
	IV: 100°C/160°C		$\tau_{Rk,eq,C1}$	[N/mm ²]	4,0	4,5	4,5	5,0	5,0	5,0	5,0	5,0	5,0	5,0
Increasing factors for concrete		ψ_c	[-]	1,0										
Characteristic bond resistance depending on the concrete strength class		$\tau_{Rk,eq,C1} =$		$\psi_c \cdot \tau_{Rk,eq,C1,(C20/25)}$										
Installation factor														
for dry and wet concrete	CAC	γ_{inst}	[-]	1,0										
	HDB			1,2										
for flooded bore hole	CAC			1,4										
<p>1) f_{uk} shall be taken from the specifications of reinforcing bars</p> <p>2) in absence of national regulation</p>														
ABS Injection System UM-H for concrete											Annex C 18			
Performances Characteristic values of tension loads under seismic action (performance category C1) for a working life of 50 years (rebar)														

Table C22: Characteristic values of tension loads under seismic action (performance category C1) for a working life of 100 years													
Reinforcing bar			Ø 8	Ø 10	Ø 12	Ø 14	Ø 16	Ø 20	Ø 24	Ø 25	Ø 28	Ø 32	
Steel failure													
Characteristic tension resistance	$N_{Rk,s,eq,C1}$	[kN]	$1,0 \cdot A_s \cdot f_{uk}^{1)}$										
Cross section area	A_s	[mm ²]	50	79	113	154	201	314	452	491	616	804	
Partial factor	$\gamma_{Ms,N}$	[-]	1,4 ²⁾										
Combined pull-out and concrete failure													
Characteristic bond resistance in cracked and uncracked concrete C20/25													
Temperature range	I: 24°C/40°C	Dry, wet concrete and flooded bore hole	$\tau_{Rk,eq,C1}$	[N/mm ²]	4,5	4,5	4,5	4,5	4,5	4,0	4,0	4,0	4,0
	II: 50°C/80°C		$\tau_{Rk,eq,C1}$	[N/mm ²]	4,5	4,5	4,5	4,5	4,5	4,0	4,0	4,0	4,0
Increasing factors for concrete		ψ_c	[-]	1,0									
Characteristic bond resistance depending on the concrete strength class		$\tau_{Rk,eq,C1} =$		$\psi_c \cdot \tau_{Rk,eq,C1,(C20/25)}$									
Installation factor													
for dry and wet concrete	CAC	γ_{inst}	[-]	1,0									
	HDB			1,2									
for flooded bore hole	CAC			1,4									
<p>1) f_{uk} shall be taken from the specifications of reinforcing bars</p> <p>2) in absence of national regulation</p>													
ABS Injection System UM-H for concrete											Annex C 19		
<p>Performances Characteristic values of tension loads under seismic action (performance category C1) for a working life of 100 years (rebar)</p>													

Table C23: Characteristic values of shear loads under seismic action (performance category C1) for a working life of 50 and 100 years												
Reinforcing bar			Ø 8	Ø 10	Ø 12	Ø 14	Ø 16	Ø 20	Ø 24	Ø 25	Ø 28	Ø 32
Steel failure												
Characteristic shear resistance	$V_{Rk,s,eq}$	[kN]	$0,35 \cdot A_s \cdot f_{uk}^{1)}$									
Cross section area	A_s	[mm ²]	50	79	113	154	201	314	452	491	616	804
Partial factor	$\gamma_{Ms,V}$	[-]	$1,5^{2)}$									
Factor for annular gap	α_{gap}	[-]	$0,5 (1,0)^{3)}$									
<p>1) f_{uk} shall be taken from the specifications of reinforcing bars</p> <p>2) in absence of national regulation</p> <p>3) Value in brackets valid for filled annular gap between fastener and clearance hole in the fixture. Use of special filling washer Annex A 3 is recommended</p>												
ABS Injection System UM-H for concrete											Annex C 20	
Performances Characteristic values of shear loads under seismic action (performance category C1) for a working life of 50 and 100 years (rebar)												

Table C24: Characteristic values of tension loads under seismic action (performance category C2) for a working life of 50 years								
Threaded rod			M12	M16	M20	M24		
Steel failure								
Characteristic tension resistance, Steel, strength class 8.8 Stainless Steel A4 and HCR, Strength class ≥ 70			$N_{Rk,s,eq,C2}$	[kN]	$1,0 \cdot N_{Rk,s}$			
Partial factor			$\gamma_{Ms,N}$	[-]	see Table C1			
Combined pull-out and concrete failure								
Characteristic bond resistance in cracked and uncracked concrete C20/25								
Temperature range	I: 24°C/40°C	Dry, wet concrete and flooded bore hole	$\tau_{Rk,eq,C2}$	[N/mm ²]	3,6	3,5	3,3	2,3
	II: 50°C/80°C		$\tau_{Rk,eq,C2}$	[N/mm ²]	3,6	3,5	3,3	2,3
	III: 72°C/120°C		$\tau_{Rk,eq,C2}$	[N/mm ²]	3,1	3,0	2,8	2,0
	IV: 160°C/100°C		$\tau_{Rk,eq,C2}$	[N/mm ²]	2,5	2,7	2,5	1,8
Increasing factors for concrete			ψ_c	[-]	1,0			
Characteristic bond resistance depending on the concrete strength class			$\tau_{Rk,eq,C2} =$		$\psi_c \cdot \tau_{Rk,eq,C2,(C20/25)}$			
Installation factor								
for dry and wet concrete	CAC	γ_{inst}	[-]	1,0				
	HDB			1,2				
for flooded bore hole	CAC			1,4				
ABS Injection System UM-H for concrete						Annex C 21		
Performances Characteristic values of tension loads under seismic action (performance category C2) for a working life of 50 years (threaded rod)								

Table C25: Characteristic values of tension loads under seismic action (performance category C2) for a working life of 100 years								
Threaded rod		M12	M16	M20	M24			
Steel failure								
Characteristic tension resistance, Steel, strength class 8.8 Stainless Steel A4 and HCR, Strength class ≥ 70		$N_{Rk,s,eq,C2}$	[kN]	$1,0 \cdot N_{Rk,s}$				
Partial factor		$\gamma_{Ms,N}$	[-]	see Table C1				
Combined pull-out and concrete failure								
Characteristic bond resistance in cracked and uncracked concrete C20/25								
Temperature range	I: 24°C/40°C	Dry, wet concrete and flooded bore hole	$\tau_{Rk,eq,C2}$	[N/mm ²]	3,6	3,5	3,3	2,3
	II: 50°C/80°C		$\tau_{Rk,eq,C2}$	[N/mm ²]	3,6	3,5	3,3	2,3
Increasing factors for concrete		ψ_c	[-]	1,0				
Characteristic bond resistance depending on the concrete strength class		$\tau_{Rk,eq,C2} =$		$\psi_c \cdot \tau_{Rk,eq,C2,(C20/25)}$				
Installation factor								
for dry and wet concrete	CAC	γ_{inst}	[-]	1,0				
	HDB			1,2				
for flooded bore hole	CAC			1,4				
ABS Injection System UM-H for concrete					Annex C 22			
Performances Characteristic values of tension loads under seismic action (performance category C2) for a working life of 100 years (threaded rod)								

Table C26: Characteristic values of shear loads under seismic action (performance category C2) for a working life of 50 and 100 years						
Threaded rod			M12	M16	M20	M24
Steel failure						
Characteristic shear resistance Steel, strength class 8.8 Stainless Steel A4 and HCR, Strength class ≥ 70	$V_{Rk,s,eq,C2}$	[kN]	$0,70 \cdot V_{Rk,s}^0$			
Partial factor	$\gamma_{Ms,V}$	[-]	see Table C1			
Factor for annular gap	α_{gap}	[-]	$0,5 (1,0)^{1)}$			
1) Value in brackets valid for filled annular gap between fastener and clearance hole in the fixture. Use of special filling washer Annex A 3 is recommended						
Table C27: Displacements under tension load						
Threaded rod			M12	M16	M20	M24
Cracked concrete under seismic action (performance category C2) for a working life of 50 and 100 years						
All temperature ranges	$\delta_{N,eq,C2(50\%)} =$	[mm]	0,24	0,27	0,29	0,27
	$\delta_{N,eq,C2(DLS)}$					
	$\delta_{N,eq,C2(100\%)} =$	[mm]	0,55	0,51	0,50	0,58
	$\delta_{N,eq,C2(ULS)}$					
Table C28: Displacements under shear load						
Threaded rod			M12	M16	M20	M24
Cracked concrete under seismic action (performance category C2) for a working life of 50 and 100 years						
All temperature ranges	$\delta_{V,eq,C2(50\%)} =$	[mm]	3,6	3,0	3,1	3,5
	$\delta_{V,eq,C2(DLS)}$					
	$\delta_{V,eq,C2(100\%)} =$	[mm]	7,0	6,6	7,0	9,3
	$\delta_{V,eq,C2(ULS)}$					
ABS Injection System UM-H for concrete						Annex C 23
Performances Characteristic values of shear loads Displacements under seismic action (performance category C2) for a working life of 50 and 100 years (threaded rod)						

Table C29: Characteristic values of tension and shear loads under fire exposure in hammer drilled holes (HD), compressed air drilled holes (CD) and in hammer drilled holes with hollow drill bit (HDB)														
Threaded rod				M8	M10	M12	M16	M20	M24	M27	M30			
Steel failure														
Characteristic tension resistance; Steel, Stainless Steel A2, A4 and HCR, strength class 5.8 resp. 50 and higher	$N_{Rk,s,fi}$	[kN]	Fire exposure time [min]	30	1,1	1,7	3,0	5,7	8,8	12,7	16,5	20,2		
				60	0,9	1,4	2,3	4,2	6,6	9,5	12,4	15,1		
				90	0,7	1,0	1,6	3,0	4,7	6,7	8,7	10,7		
				120	0,5	0,8	1,2	2,2	3,4	4,9	6,4	7,9		
Characteristic bond resistance in cracked and uncracked concrete C20/25 up to C50/60 under fire conditions for a given temperature θ														
Temperature reduction factor	$k_{fi,p}(\theta)$	[-]	$\theta < 24^\circ\text{C}$		1,0									
			$24^\circ\text{C} \leq \theta \leq 379^\circ\text{C}$		$1,301 \cdot e^{-0,011 \cdot \theta} \leq 1,0$									
			$\theta > 379^\circ\text{C}$		0,0									
<p>The graph shows the reduction factor $k_{fi,p}(\theta)$ as a function of temperature θ in degrees Celsius. The y-axis ranges from 0.0 to 1.0, and the x-axis ranges from 0 to 450. The curve is constant at 1.0 until 24°C, then follows the equation $1,301 \cdot e^{-0,011 \cdot \theta}$ until 379°C, where it drops to 0.0.</p>														
Characteristic bond resistance for a given temperature (θ)	$\tau_{Rk,fi}(\theta)$	[N/mm ²]	$k_{fi,p}(\theta) \cdot \tau_{Rk,cr,(C20/25)}^{1)}$											
Steel failure without lever arm														
Characteristic shear resistance; Steel, Stainless Steel A2, A4 and HCR, strength class 5.8 resp. 50 and higher	$V_{Rk,s,fi}$	[kN]	Fire exposure time [min]	30	1,1	1,7	3,0	5,7	8,8	12,7	16,5	20,2		
				60	0,9	1,4	2,3	4,2	6,6	9,5	12,4	15,1		
				90	0,7	1,0	1,6	3,0	4,7	6,7	8,7	10,7		
				120	0,5	0,8	1,2	2,2	3,4	4,9	6,4	7,9		
Steel failure with lever arm														
Characteristic bending moment; Steel, Stainless Steel A2, A4 and HCR, strength class 5.8 resp. 50 and higher	$M^0_{Rk,s,fi}$	[Nm]	Fire exposure time [min]	30	1,1	2,2	4,7	12,0	23,4	40,4	59,9	81,0		
				60	0,9	1,8	3,5	9,0	17,5	30,3	44,9	60,7		
				90	0,7	1,3	2,5	6,3	12,3	21,3	31,6	42,7		
				120	0,5	1,0	1,8	4,7	9,1	15,7	23,3	31,5		
¹⁾ $\tau_{Rk,cr,(C20/25)}$ characteristic bond resistance for cracked concrete for concrete strength class C20/25 for the relevant temperature range														
ABS Injection System UM-H for concrete											Annex C 24			
Performances Characteristic values of tension and shear loads under fire exposure (threaded rod)														

Table C30: Characteristic values of tension and shear loads under fire exposure in hammer drilled holes (HD), compressed air drilled holes (CD) and in hammer drilled holes with hollow drill bit (HDB)										
Internal threaded anchor rods				IG-M6	IG-M8	IG-M10	IG-M12	IG-M16	IG-M20	
Steel failure										
Characteristic tension resistance; Steel, Stainless Steel A4 and HCR, strength class 5.8 and 8.8 resp. 70	$N_{Rk,s,fi}$	[kN]	Fire exposure time [min]	30	0,3	1,1	1,7	3,0	5,7	8,8
				60	0,2	0,9	1,4	2,3	4,2	6,6
				90	0,2	0,7	1,0	1,6	3,0	4,7
				120	0,1	0,5	0,8	1,2	2,2	3,4
Characteristic bond resistance in cracked and uncracked concrete C20/25 up to C50/60 under fire conditions for a given temperature θ										
Temperature reduction factor	$k_{fi,p}(\theta)$	[-]	$\theta < 24^{\circ}\text{C}$		1,0					
			$24^{\circ}\text{C} \leq \theta \leq 379^{\circ}\text{C}$		$1,301 \cdot e^{-0,011 \cdot \theta} \leq 1,0$					
			$\theta > 379^{\circ}\text{C}$		0,0					
Characteristic bond resistance for a given temperature (θ)	$\tau_{Rk,fi}(\theta)$	[N/mm ²]		$k_{fi,p}(\theta) \cdot \tau_{Rk,cr,(C20/25)}^{1)}$						
Steel failure without lever arm										
Characteristic shear resistance; Steel, Stainless Steel A4 and HCR, strength class 5.8 and 8.8 resp. 70	$V_{Rk,s,fi}$	[kN]	Fire exposure time [min]	30	0,3	1,1	1,7	3,0	5,7	8,8
				60	0,2	0,9	1,4	2,3	4,2	6,6
				90	0,2	0,7	1,0	1,6	3,0	4,7
				120	0,1	0,5	0,8	1,2	2,2	3,4
Steel failure with lever arm										
Characteristic bending moment; Steel, Stainless Steel A4 and HCR, strength class 5.8 and 8.8 resp. 70	$M^0_{Rk,s,fi}$	[Nm]	Fire exposure time [min]	30	0,2	1,1	2,2	4,7	12,0	23,4
				60	0,2	0,9	1,8	3,5	9,0	17,5
				90	0,1	0,7	1,3	2,5	6,3	12,3
				120	0,1	0,5	1,0	1,8	4,7	9,1
1) $\tau_{Rk,cr,(C20/25)}$ characteristic bond resistance for cracked concrete for concrete strength class C20/25 for the relevant temperature range										
ABS Injection System UM-H for concrete									Annex C 25	
Performances Characteristic values of tension and shear loads under fire exposure (internal threaded anchor rod)										

Table C31: Characteristic values of tension and shear loads under fire exposure in hammer drilled holes (HD), compressed air drilled holes (CD) and in hammer drilled holes with hollow drill bit (HDB)

Reinforcing bar				Ø 8	Ø 10	Ø 12	Ø 14	Ø 16	Ø 20	Ø 24	Ø 25	Ø 28	Ø 32	
Steel failure														
Characteristic tension resistance; BSt 500	$N_{Rk,s,fi}$	[kN]	Fire exposure time [min]	30	0,5	1,2	2,3	3,1	4,0	6,3	9,0	9,8	12,3	16,1
				60	0,5	1,0	1,7	2,3	3,0	4,7	6,8	7,4	9,2	12,1
				90	0,4	0,8	1,5	2,0	2,6	4,1	5,9	6,4	8,0	10,5
				120	0,3	0,6	1,1	1,5	2,0	3,1	4,5	4,9	6,2	8,0
Characteristic bond resistance in cracked and uncracked concrete C20/25 up to C50/60 under fire conditions for a given temperature θ														
Temperature reduction factor	$k_{fi,p}(\theta)$	[-]	$\theta < 22^\circ\text{C}$		1,0									
			$22^\circ\text{C} \leq \theta \leq 370^\circ\text{C}$		$1,268 \cdot e^{-0,011 \cdot \theta} \leq 1,0$									
			$\theta > 370^\circ\text{C}$		0,0									
<p>The graph shows the reduction factor $k_{fi}(\theta)$ as a function of temperature θ in degrees Celsius. The y-axis ranges from 0.0 to 1.0, and the x-axis ranges from 0 to 450. The curve is constant at 1.0 for temperatures up to 22°C. At 22°C, it begins to decrease, following an exponential decay curve that reaches 0.0 at 370°C. A vertical dashed red line is drawn at 22°C.</p>														
Characteristic bond resistance for a given temperature (θ)	$\tau_{Rk,fi}(\theta)$	[N/mm ²]	$k_{fi,p}(\theta) \cdot \tau_{Rk,cr,(C20/25)}^{1)}$											
Steel failure without lever arm														
Characteristic shear resistance; BSt 500	$V_{Rk,s,fi}$	[kN]	Fire exposure time [min]	30	0,5	1,2	2,3	3,1	4,0	6,3	9,0	9,8	12,3	16,1
				60	0,5	1,0	1,7	2,3	3,0	4,7	6,8	7,4	9,2	12,1
				90	0,4	0,8	1,5	2,0	2,6	4,1	5,9	6,4	8,0	10,5
				120	0,3	0,6	1,1	1,5	2,0	3,1	4,5	4,9	6,2	8,0
Steel failure with lever arm														
Characteristic bending moment; BSt 500	$M^0_{Rk,s,fi}$	[Nm]	Fire exposure time [min]	30	0,6	1,8	4,1	6,5	9,7	18,8	32,6	36,8	51,7	77,2
				60	0,5	1,5	3,1	4,8	7,2	14,1	24,4	27,6	38,8	57,9
				90	0,4	1,2	2,6	4,2	6,3	12,3	21,2	23,9	33,6	50,2
				120	0,3	0,9	2,0	3,2	4,8	9,4	16,3	18,4	25,9	38,6
1) $\tau_{Rk,cr,(C20/25)}$ characteristic bond resistance for cracked concrete for concrete strength class C20/25 for the relevant temperature range														
ABS Injection System UM-H for concrete											Annex C 26			
Performances Characteristic values of tension and shear loads under fire exposure (reinforcing bar)														